



# AR Series Installation Manual

 SAFETY US-CA  
 MARINE US  
 E477827

 SAFETY US-CA  
 MARINE US  
 E477829

## APPLICATION

The AR luminaire is an industrial-grade product suitable for harsh and hazardous locations. Installation areas include indoor, outdoor, and wet locations. Frequent exposure to moisture, dirt, corrosion, vibration, and rough usage is common for this product family. The AR fixtures have certifications for use on marine vessels inside, outside and in other severely wet saltwater environments. Part numbers containing "-HZ-" are approved for use in hazardous locations.

UL File Numbers:                    Nemalux General Location: E477827  
    Nemalux Hazardous Location: E477829

AR luminaires are suitable for use in the following areas as defined by the National Electrical Code (NEC) and the Canadian Electrical Code (CEC):

### Certifications

All models:                            UL 1598, UL 1598A and UL 8750;  
    CSA C22.2 No. 250.0 and CSA C22.2 No. 250.13  
    ABS Listed

### Certifications

Hazardous Location models (ARXX-XXX-XX-XX-HZ-XX):

UL 844, CSA C22.2 No. 137  
 Hazardous Location Approved Locations:  
 Class I, Division 2, Groups ABCD, T4;  
 Class II, Division 2, Groups FG, T4A;  
 Class III;  
 Class I, Zone 2, Group IIC;  
 Zone 22

Housing:                                High pressure die-cast aluminum body with a polycarbonate lens.

Input Voltage:                        Based on luminaire suffix in table below:  
    Suffix - AC: 120-277 VAC | Suffix - HV: 347-480 VAC

Inrush Current:                      AR (AC): Inrush Current Peak / >50% Duration 120V: 62A / 210uS 277V: 148A / 200uS  
    AR (HV): Inrush Current 347V: 118.4A / 97uS Peak / >50% Duration 480V: 148A / 79uS

Connections:                         2 x 3/4" NPT Conduit | Black: Line | White: Neutral/Line 2 | Green: Ground  
    *Optional: Violet (Purple): 0-10V Dimming (+) | Grey: 0-10V Dimming (-)*  
    For connections use wire rated to a minimum of 90°C. Class 1 Wiring only.  
    Dimming control wires must be rated 300V minimum for luminaires with suffix AC,  
    600V minimum for luminaires with suffix HV.

Ingress Protection:                IP66/67 | Suitable for wet locations. Marine outside type (salt water).

## APPLICATION CONT.

### Electrical Rating:

General Location (ARXX-XXX-XX-XX-GN-XX),  
Hazardous Location (ARXX-XXX-XX-XX-HZ-XX)

General Location High Intensity model  
(ARXXH-XXX-XX-XX-GN-XX)

| LUMINANCE | INPUT VOLTAGE | RATED WATTAGE [Watts] | RATED VOLTAGE [Volts] | FREQUENCY [Hz] |
|-----------|---------------|-----------------------|-----------------------|----------------|
| AR10      | AC            | 107                   | 120-277               | 50/60          |
|           | HV            | 129                   | 347-480               | 50/60          |
| AR15      | AC            | 145                   | 120-277               | 50/60          |
|           | HV            | 145                   | 347-480               | 50/60          |
| AR20      | AC            | 190                   | 120-277               | 50/60          |
|           | HV            | 187                   | 347-480               | 50/60          |
| AR25      | AC            | 247                   | 120-277               | 50/60          |
|           | HV            | 248                   | 347-480               | 50/60          |
| AR30      | AC            | 312                   | 120-277               | 50/60          |
|           | HV            | 310                   | 347-480               | 50/60          |

| LUMINANCE | INPUT VOLTAGE | RATED WATTAGE [Watts] | RATED VOLTAGE [Volts] | FREQUENCY [Hz] | CURRENT [A] |
|-----------|---------------|-----------------------|-----------------------|----------------|-------------|
| AR20H     | AC            | 130                   | 120-277               | 50/60          | 1.0A/0.5A   |
|           | HV            | 130                   | 347-480               | 50/60          | 0.4A/0.3A   |
| AR25H     | AC            | 150                   | 120-277               | 50/60          | 1.3A/0.6A   |
|           | HV            | 150                   | 347-480               | 50/60          | 0.5A/0.4A   |
| AR30H     | AC            | 190                   | 120-277               | 50/60          | 1.5A/0.7A   |
|           | HV            | 190                   | 347-480               | 50/60          | 0.6A/0.4A   |
| AR35H     | AC            | 210                   | 120-277               | 50/60          | 1.7A/0.8A   |
|           | HV            | 210                   | 347-480               | 50/60          | 0.6A/0.5A   |
| AR40H     | AC            | 250                   | 120-277               | 50/60          | 2.0A/0.9A   |
|           | HV            | 250                   | 347-480               | 50/60          | 0.8A/0.6A   |
| AR45H     | AC            | 275                   | 120-277               | 50/60          | 2.3A/1.0A   |
|           | HV            | 275                   | 347-480               | 50/60          | 0.8A/0.6A   |
| AR50H     | AC            | 290                   | 120-277               | 50/60          | 2.4A/1.0A   |
|           | HV            | 290                   | 347-480               | 50/60          | 0.9A/0.6A   |

### Temperature Range:

General Location  
(ARXX-XXX-XX-XX-GN-XX)

General Location High Intensity model  
(ARXXH-XXX-XX-XX-GN-XX)

| LUMINANCE              | INPUT VOLTAGE  | AMBIENT TEMP [°C] |
|------------------------|----------------|-------------------|
| AR10, AR15, AR20, AR25 | AC             | -40 to 55         |
|                        | HV             | -40 to 50         |
| AR30                   | AC, HV Optical | -40 to 45         |
|                        | AC Flood       | -40 to 40         |
|                        | HV Flood       | -40 to 45         |

| LUMINANCE    | INPUT VOLTAGE | AMBIENT TEMP [°C] |
|--------------|---------------|-------------------|
| AR20H, AR25H | AC            | -40 to 53         |
|              | HV            | -40 to 48         |
| AR30H, AR40H | AC            | -40 to 49         |
|              | HV            | -40 to 40         |
| AR45H, AR50H | AC            | -40 to 42         |
|              | HV            | -40 to 40         |

### Hazardous Location (ARXX-XXX-XX-XX-HZ-XX)

| LUMINANCE        | INPUT VOLTAGE | OPTICAL MODELS    |                        | FLOOD MODELS      |                        | ALL MODELS              |
|------------------|---------------|-------------------|------------------------|-------------------|------------------------|-------------------------|
|                  |               | AMBIENT TEMP [°C] | CLASS I, DIV 2 T-CODES | AMBIENT TEMP [°C] | CLASS I, DIV 2 T-CODES | CLASS II, DIV 2 T-CODES |
| AR10, AR15, AR20 | AC            | -40 to 55         | T3C                    | -40 to 55         | T4A                    | T5                      |
|                  | HV            | -40 to 54         | T3C                    | -40 to 51         | T4                     | T5                      |
| AR25             | AC            | -40 to 51         | T3C                    | -40 to 55         | T4A                    | T5                      |
|                  | HV            | -40 to 44         | T3B                    | -40 to 50         | T4A                    | T5                      |
| AR30             | AC            | -40 to 43         | T3                     | -40 to 42         | T4A                    | T5                      |
|                  | HV            | -40 to 43         | T3                     | -40 to 40         | T3                     | T5                      |

**⚠ WARNING / ATTENTION**

To avoid the risk of fire, explosion, or electric shock, this product should be installed, inspected, and maintained by a qualified electrician only, in accordance with all applicable electrical codes.

Éviter tout risque d'incendie, d'explosion ou d'électrocution, ce produit doit être installé, inspecté et entretenu par un électricien qualifié uniquement, conformément à tous codes électriques applicables.

**⚠ WARNING / ATTENTION**

To reduce the risk of electric shock, disconnect the luminaire from the supply circuit before opening for installation and servicing. Keep tightly closed when in operation.

Pour réduire le risque de choc électrique, débranchez le luminaire du circuit d'alimentation avant l'ouverture pour l'installation et l'entretien. Gardez hermétiquement fermé pendant le fonctionnement.



**WARNING ATTENTION**

**Potential Electrostatic Charging Hazard**  
**Risque potentiel de charge électrostatique**

Avoid electrostatic discharge:  
 • Clean exterior lens surface with damp cloth only  
 • Éviter les décharges électrostatiques: nettoyer la surface extérieure de la lentille uniquement avec un chiffon humide

## AR-SM – SURFACE/CEILING MOUNT INSTALLATION (Ordered Separately)

If using a different mounting accessory, refer to the corresponding page.

This AR-SM kit is intended for use with UL listed AR luminaire, as marked on the luminaire nameplate.

### Accessory Package Contents

| AR-SM | QTY | PART NAME                        |
|-------|-----|----------------------------------|
|       | 2   | SURFACE/SUSPENSION MOUNT BRACKET |
|       | 4   | M6 X 12mm HEX HEAD CAP SCREW     |
|       | 4   | M6 FLAT WASHER                   |



## INSTALLATION STEPS

### STEP 1.

Inspect shipping package and contents to ensure no damage has occurred during shipping.

### STEP 2.

Remove 8x M6 hex cap bracket mounting screws from the head and reinstall with included surface/suspension mount brackets. See the diagram for the orientation of brackets. Torque M6 bolts to 5 Nm (45 in-lbs).

### STEP 3.

#### A) For surface mounting configurations.

Mount the luminaire in the desired ceiling location using 4x 1/4-20 OR 4x M6 fasteners and washers (not provided). One mounting hole on each bracket is keyed to allow partial pre-installation of two fasteners for ease of installation.

#### B) For ceiling mounting configurations.

Connect 4x anchors to the 12.7mm (0.5") holes. Suspension hardware (not provided) must be rated for at least 180 lbs.

### STEP 4.

Open the AR lens with a 7mm socket or wrench and allow the lens to hang via the retention strap.

#### Note:

*Screws are captive and will remain attached to the lens for ease of reinstall and to prevent loss of fasteners.*

### STEP 5.

For convenience, spring cage wire connectors have been provided. 12-28AWG solid or stranded wire with a strip length of 8-10mm (0.35-0.39") is supported. If user wiring requires it, the connectors may be replaced by an alternate listed connector.

Make wiring connections from branch circuit conductors to factory-provided lead wires. Refer to NEC/CEC codes and follow all applicable local standards. See the wiring diagram on Page 4.

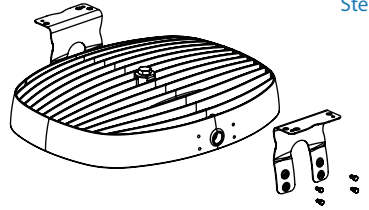
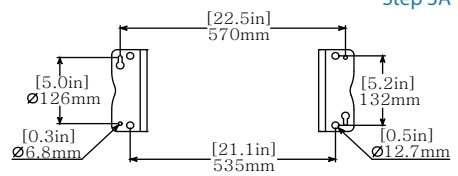
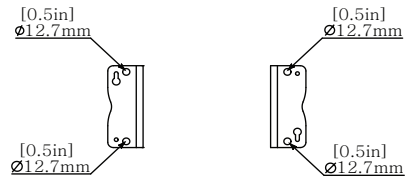
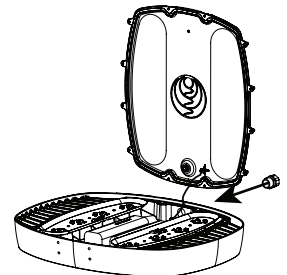
**Step 2**

**Step 3A**

**Step 3B**

**Step 5**

#### WARNING:

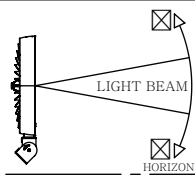
For Class II, Division 2, Zone 22, and Class III hazardous locations, the AR head must not face upwards by any degree beyond the vertical position.

#### ATTENTION:

Le luminaire (AR) ne doit pas être orientée vers le haut de quelque degré que ce soit au-delà de la position verticale pour les emplacements dangereux de Classe II, Division 2, Zone 22 et Classe III



## AR-SM – SURFACE/CEILING MOUNT INSTALLATION CONT. (Ordered Separately)

### INSTALLATION STEPS CONT.

For 0-10V analog dimming control, connect Violet (PURPLE) (+) and Gray (-) to 0-10VDC control wiring:

- 0-10V Interface can be wired as a Class 1 or Class 2 circuit.
- LED Drivers will source a combined maximum of 400µA for control needs.
- The 0-10V Controller must sink current from LED driver 0-10V control connections.
- Dimming controls must be certified and suitable for the classification of the area of their installation

Step 6

**NOTE:**

To aid in assembly and protect against ingress, a petrolatum or soap-thickened mineral oil-based thread lubricant/sealant is necessary.

If the fixture has unused conduit openings, plug them to maintain the enclosure's integrity.

**STEP 6.**

Close the AR lens. Ensure the retention cable is not pinched between the AR head and the AR lens. Tighten the lens bolts using a 7mm socket or box wrench to 1.7 N-m (15 in-lbs) in the order designated in the diagram to ensure gasket sealing.

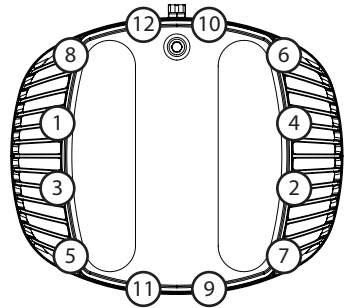

### WIRING DIAGRAM

- BLACK - LINE
- WHITE - NEUTRAL/LINE 2
- GREEN - GROUND
- VIOLET (PURPLE) - DIM (+)\*
- GREY - DIM (-)\*

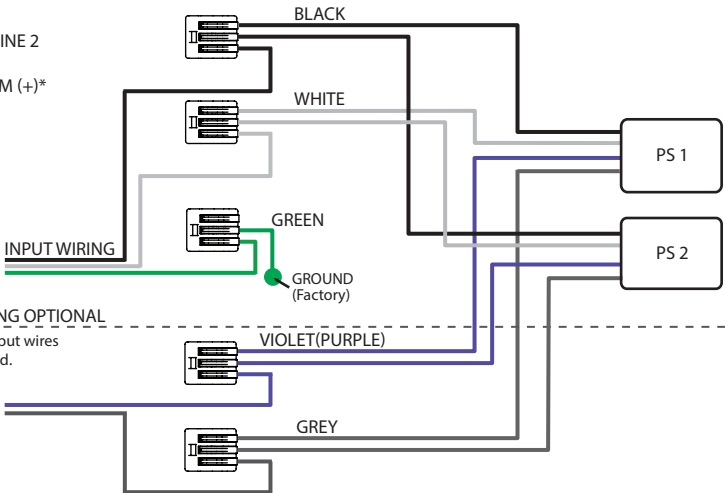

**0-10V DIMMING WIRING OPTIONAL**

\*Omit purple and grey input wires if dimming is not enabled.

## AR-PM – POLE MOUNT INSTALLATION (Ordered Separately)

If using a different mounting accessory, refer to the corresponding page.

This AR-PM kit is intended for UL listed AR luminaires, as marked on the luminaire nameplate.

### Accessory Package Contents

| AR-PM | QTY | PART NAME                             |
|-------|-----|---------------------------------------|
|       | 1   | POLE MOUNT                            |
|       | 1   | POLE MOUNT GASKET                     |
|       | 4   | M6 X 25mm HEX HEAD CAP SCREW          |
|       | 4   | M6 FLAT WASHER                        |
|       | 1   | M6 X 16mm HEX HEAD CAP SCREW          |
|       | 1   | 3/4" NPT THREADED SMOOTH BORE BUSHING |



## INSTALLATION STEPS

### STEP 1.

Inspect the shipping package and its contents to ensure no damage occurred during shipping.

### STEP 2.

Install the provided plastic 3/4" bushing into the side 3/4" NPT entry.

### STEP 3.

Install pole mount and gasket with adhesive side applied to mount using included M6 bolts and washers. Torque to 5 Nm (45 in-lbs).

### STEP 4.

Thread luminaire assembly onto 1-1/2" NPT pole.

### NOTE:

To aid in assembly and protect against ingress, a petrolatum or soap-thickened mineral oil-based thread lubricant/sealant is necessary.

If the fixture has unused conduit openings, plug them to maintain the enclosure's integrity.

### STEP 5.

Insert and tension M6 set screw to the pole to lock rotation.

### STEP 6.

Continue installation with STEP 4 on PAGE 3.

Step 3

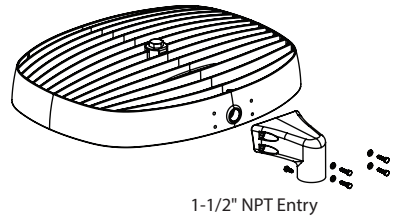

Step 5

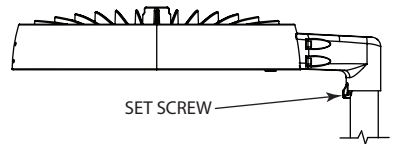

### WARNING:

For Class II, Division 2, Zone 22, and Class III hazardous locations, the AR head must not face upwards by any degree beyond the vertical position.

### ATTENTION:

Le luminaire (AR) ne doit pas être orientée vers le haut de quelque degré que ce soit au-delà de la position verticale pour les emplacements dangereux de Classe II, Division 2, Zone 22 et Classe III

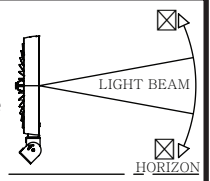

## AR-WM – WALL MOUNT INSTALLATION (Ordered Separately)

If using a different mounting accessory, refer to the corresponding page.

This AR-WM kit is intended for UL listed AR luminaires, as marked on the luminaire nameplate.

### Accessory Package Contents

| AR-WM | QTY | PART NAME                            |
|-------|-----|--------------------------------------|
|       | 1   | WALL MOUNT                           |
|       | 1   | WALL MOUNT PLATE                     |
|       | 1   | WALL MOUNT PLATE SIDE GASKET         |
|       | 1   | WALL MOUNT GASKET                    |
|       | 4   | 6 x 25mm SOCKET HEAD CAP SCREW       |
|       | 4   | M4x 10mm FLAT HEAD SOCKET CAP SCREW  |
|       | 4   | M6 FLAT WASHER                       |
|       | 3   | 3/4 NPT HEX CAP PLUG                 |
|       | 1   | 3/4 NPT THREADED SMOOTH BORE BUSHING |



## INSTALLATION STEPS

### STEP 1.

Inspect the shipping package and its contents to ensure no damage occurred during shipping.

### STEP 2.

Install the provided 3/4" NPT conduit plugs in the desired locations on the wall mount. All NPT entries not used for wiring connections must be plugged in to maintain the ingress rating. Torque to 10 Nm (88 in-lbs).

### NOTE:

To aid in assembly and protect against ingress, a petrolatum or soap-thickened mineral oil-based thread lubricant/sealant is necessary.

If the fixture has unused conduit openings, plug them to maintain the enclosure's integrity.

### STEP 3.

Install the provided 3/4" NPT plastic bushing onto the side NPT entry on the AR head and rotate so that flats are parallel to the lens surface to avoid interference with mount hardware.

### STEP 4.

Install the wall mount main body, which includes M6 bolts, washers, and an adhesive-backed gasket. Apply the gasket to the mount with the adhesive-backed side. Torque to 5 Nm (45 in-lbs).

### STEP 5.

Install back cover plate with 4x M4 Flat head screws and adhesive backed gasket. Apply a gasket with an adhesive side to mount the main body. Torque to 1.7 N-m (15 in-lbs).

### STEP 6.

Mount luminaire assembly to the desired location using 4x 1/4-20 M6 screws or bolts (not provided).

### STEP 7.

Continue installation with STEP 4 on PAGE 3.

### Steps 2 through 5

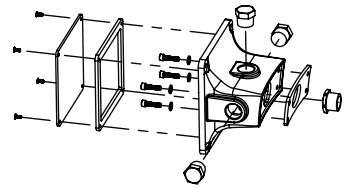

### Step 6

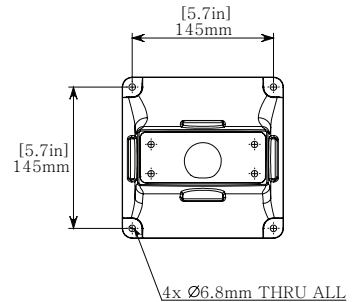

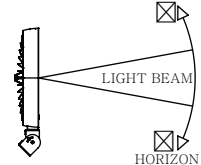
|  |   |  |
|--|---|--|
| <p><b>WARNING:</b><br/>For Class II, Division 2, Zone 22, and Class III hazardous locations, the AR head must not face upwards by any degree beyond the vertical position.</p> | <p><b>ATTENTION:</b><br/>Le luminaire (AR) ne doit pas être orientée vers le haut de quelque degré que ce soit au-delà de la position verticale pour les emplacements dangereux de Classe II, Division 2, Zone 22 et Classe III</p> |  |
|--|---|--|

## AR-WM2 – WALL MOUNT 2 INSTALLATION (Ordered Separately)

If using a different mounting accessory, refer to the corresponding page.

This AR-WM2 kit is intended for UL listed AR luminaires, as marked on the luminaire nameplate.

### Accessory Package Contents

| AR-WM2 | QTY | PART NAME                            |
|--------|-----|--------------------------------------|
|        | 1   | WALL MOUNT                           |
|        | 1   | WALL MOUNT LID                       |
|        | 1   | WALL MOUNT GASKET                    |
|        | 4   | 6 x 25mm SOCKET HEAD CAP SCREW       |
|        | 2   | M6 x 20mm SOCKET HEAD CAP SCREW      |
|        | 4   | M6 FLAT WASHER                       |
|        | 3   | 3/4 NPT HEX CAP PLUG                 |
|        | 1   | 3/4 NPT THREADED SMOOTH BORE BUSHING |
|        | 1   | WIRE EXTENSION KIT                   |



## INSTALLATION STEPS

### STEP 1.

Inspect shipping package and contents to ensure no damage has occurred during shipping.

### STEP 2.

Install provided 3/4" NPT conduit plugs in desired locations on wall mount. To maintain ingress rating all NPT entries not used for wiring connections are required to be plugged. Torque to 10 Nm (88 in-lbs).

### NOTE:

To aid in assembly and provide protection against ingress, a petrolatum or soap-thickened mineral oil-based thread lubricant/sealant is necessary.

If the fixture has unused conduit openings, plug them to maintain the enclosure's integrity.

### STEP 3.

Open AR luminaire by removing cover bolts. Note screws are captive for easy reinstallation. Install provided 3/4" smooth bore bushing in side NPT entry and extend supply wires through bushing with provided wire extensions. Close AR & torque fasteners to 1.7 N-m (15 in-lbs).

### STEP 4.

Attach the gasket to the WM2 cover face and then fasten it to the AR body with the provided M6 screws and washers. Torque to 5N-m (45in-lbs).

### STEP 5.

Mount the WM2 base in the desired location through the 4 10mm (3/8") mounting holes using appropriate fasteners and washers for the supporting material (fasteners not provided).

### STEP 6.

Route branch conductors to WM2 base. Follow the wiring method requirements of the Canadian Electrical Code or National Electrical Code for the specific location of the installation. If installing a hazardous location model (ARXX-XXX-XXX-XX-HZ-XX) in a hazardous area, follow the hazardous location wiring method requirements of the Canadian Electrical Code or National Electrical Code.

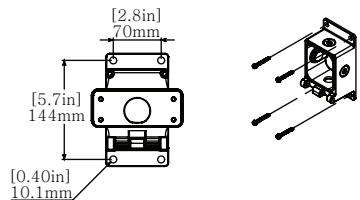
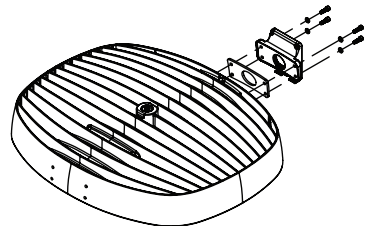
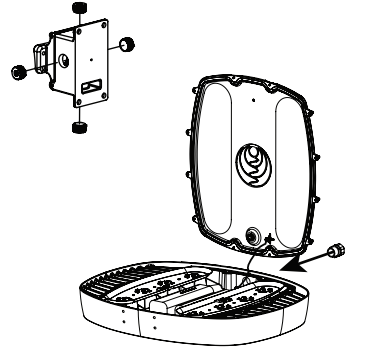

## AR-WM2 – WALL MOUNT 2 INSTALLATION (Ordered Separately)

If using a different mounting accessory, refer to the corresponding page.

### INSTALLATION STEPS CONT.

#### STEP 7.

Hang AR luminaire/WM2 cover over hinge pins in preparation for wiring.

#### STEP 8.

Make wiring connections from luminaire wires to branch circuit conductors, ensuring bonding connection with WM2 base (wiring diagram on pg 4). Follow the wiring method requirements of the Canadian Electrical Code or National Electrical Code for the specific location of the installation. If installing a hazardous location model (ARXX-XXX-XXX-XX-HZ-XX) in a hazardous area, follow the hazardous location wiring method requirements of the Canadian Electrical Code or National Electrical Code for 0-10V analog dimming control. Ensure dimming control is certified and suitable for the classification of the area of installation. Connect Violet (Purple) (+) and Gray (-) driver lead wires to 0-10VDC control wiring. LED drivers will source a combined maximum of 200 uA for control needs.

0-10V Controller must sink current from LED driver - LED drivers will source a combined maximum of 200uA for control needs.

#### STEP 9.

Swing the AR/WM2 cover upward, closing the junction box. Care is required to ensure no wires are pinched between the lid and body. Secure the lid to the body with two M6 fasteners provided.

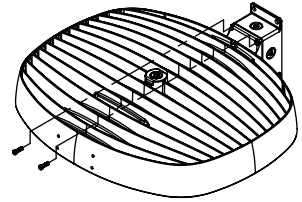
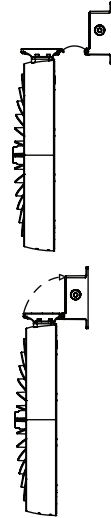

#### WARNING:

For Class II, Division 2, Zone 22, and Class III hazardous locations, the AR head must not face upwards by any degree beyond the vertical position.

#### ATTENTION:

Le luminaire (AR) ne doit pas être orientée vers le haut de quelque degré que ce soit au-delà de la position verticale pour les emplacements dangereux de Classe II, Division 2, Zone 22 et Classe III

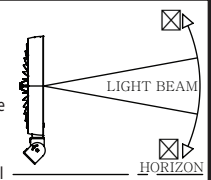



## AR-YM – YOKE MOUNT INSTALLATION (Ordered Separately)

If using a different mounting accessory, refer to the corresponding page.

This AR-YM kit is intended for UL listed AR luminaires, as marked on the luminaire nameplate.

### Accessory Package Contents

| AR-YM | QTY | PART NAME                    |
|-------|-----|------------------------------|
|       | 1   | YOKE MOUNT A                 |
|       | 1   | YOKE MOUNT B                 |
|       | 1   | CHEEK PLATE                  |
|       | 4   | 1/4-20 HEX NUT               |
|       | 4   | 1/4" FLAT WASHER             |
|       | 4   | 1/4-20 x 0.5in CARRIAGE BOLT |
|       | 4   | M6 x 25mm HEX HEAD CAP SCREW |



## INSTALLATION STEPS

### STEP 1.

Inspect the shipping package and its contents to ensure no damage occurred during shipping.

### STEP 2.

Install a suitable wiring system to the conduit opening per CEC/NEC requirements for the specific location.

#### NOTE:

To aid in assembly and protect against ingress, a petrolatum or soap-thickened mineral oil-based thread lubricant/sealant is necessary.

If the fixture has unused conduit openings, plug them to maintain the enclosure's integrity.

### STEP 3.

Loosely assemble the yoke mount with carriage bolts on the inside and washers and nuts on the outside.

#### NOTE:

Depending on which mounting hole is used in the curved slot, the luminaire may be configured for an upward or downward adjustable swing.

### STEP 4.

Thread installed wiring through openings in the yoke mount's cheek plate and yoke mount bracket. Mount yoke assembly to luminaire using 4x M6 socket head cap screws and washers (provided). Torque fasteners to 5 Nm (45 in-lbs).

### STEP 5.

Mount luminaire assembly to the desired location using 4x 1/4-20 OR M6 screws or bolts (not provided).

### STEP 6.

Adjust and aim the luminaire to the desired position. Then, torque the hardware nuts to 9 N-m (80 in-lbs).

### STEP 7.

Continue installation with STEP 4 on PAGE 3.

Step 3

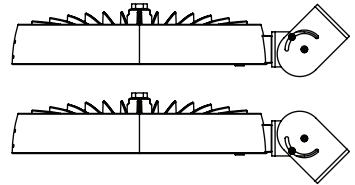
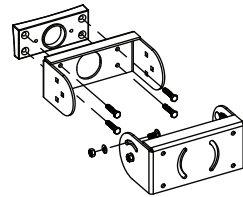

Step 5

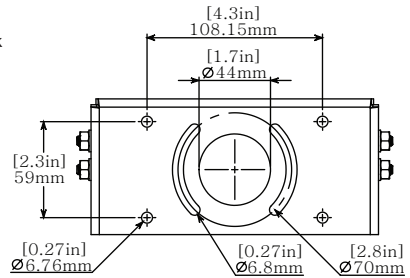

#### WARNING:

For Class II, Division 2, Zone 22, and Class III hazardous locations, the AR head must not face upwards by any degree beyond the vertical position.

#### ATTENTION:

Le luminaire (AR) ne doit pas être orientée vers le haut de quelque degré que ce soit au-delà de la position verticale pour les emplacements dangereux de Classe II, Division 2, Zone 22 et Classe III

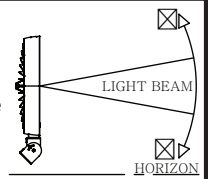

## AR-HK – HOOK PENDANT INSTALLATION (Ordered Separately)

*If using a different mounting accessory, refer to the corresponding page.*

This AR-HK kit is intended for UL listed AR luminaires, as marked on the luminaire nameplate.

### Accessory Package Contents

| AR-HK | QTY | PART NAME              |
|-------|-----|------------------------|
|       | 1   | PENDANT HOOK ASSEMBLY  |
|       | 1   | ANTI-ROTATION ASSEMBLY |



## INSTALLATION STEPS

### STEP 1.

Inspect the shipping package and its contents to ensure no damage occurred during shipping.

### STEP 2.

It is recommended that the secondary safety cables be installed by looping an appropriate steel cable or chain through the outer band of the unit and fastening a closed loop. Secondary safety hardware must be rated for a minimum of 180 lbs. Secondary safety cables made from stainless steel aircraft cable are available upon request.

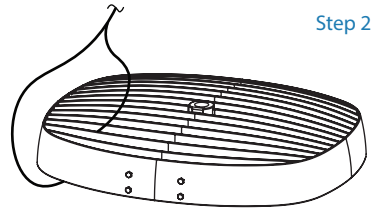

Step 2

### STEP 3.

Slide anti-rotation lock onto suspension hook assembly and install hook assembly into 3/4" NPT threaded entry. Tighten to hand tight plus 1 to 2 turns. Slide the anti-rotation lock into place and tighten the set screw to lock the unit in place.

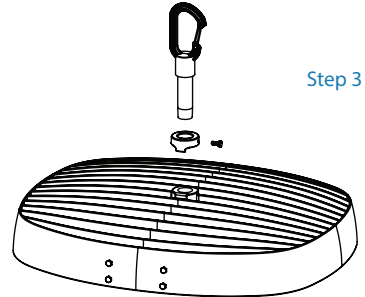

Step 3

### NOTE:

*To aid in assembly and protect against ingress, a petrolatum or soap-thickened mineral oil-based thread lubricant/sealant is necessary.*

*If the fixture has unused conduit openings, plug them to maintain the enclosure's integrity.*

### STEP 4.

Latch hook onto eyebolt or other fixed mounting loop. The mounting point must be rated for a minimum of 180 lbs.

### STEP 5.

Install the remaining loop of the secondary safety chain or steel cable to a suitable mounting location and fasten it securely.

### STEP 6.

Continue installation with STEP 4 on PAGE 3.

## AR-CM – CONDUIT MOUNT INSTALLATION (Ordered Separately)

If using a different mounting accessory, refer to the corresponding page.

This AR-CM kit is intended for UL listed AR luminaires, as marked on the luminaire nameplate.

### Accessory Package Contents

| AR-CM | QTY | PART NAME                      |
|-------|-----|--------------------------------|
|       | 1   | ANTI-ROTATION BRACKET ASSEMBLY |

## INSTALLATION STEPS

### STEP 1.

Inspect shipping package and contents to ensure no damage has occurred during shipping.

### STEP 2.

Slide anti-rotation lock onto suitably mounted hanging conduit or luminaire hanger and install luminaire onto 3/4" NPT threaded nipple. Tighten to hand tight contact plus 1 to 2 turns. Slide the anti-rotation lock into place and tighten the set screw to lock the unit in place. The fixed, rigid metal conduit must be suitably mounted, preventing rotation, and the system must be rated for 180 lbs.

### NOTE:

To aid in assembly and protect against ingress, a petrolatum or soap-thickened mineral oil-based thread lubricant/sealant is necessary.

If the fixture has unused conduit openings, plug them to maintain the enclosure's integrity.

### STEP 3.

Install a secondary safety cable by looping the appropriate steel cable or chain through the outer band of the unit and fastening it into a closed loop.

Install the remaining loop of the secondary safety chain or steel cable in a suitable mounting location and fasten it securely. Secondary safety hardware must be rated for 180 lbs.

### STEP 4.

Continue installation with STEP 4 on PAGE 3.

## WARNING / ATTENTION

AR is not permitted for conduit only mounting when installed in hazardous locations, additional mounting means must also be utilized.

AR n'est pas autorisé pour le montage sur conduit uniquement lorsqu'il est installé dans des emplacements dangereux, des moyens de montage supplémentaires doivent également être utilisés.



Step 2

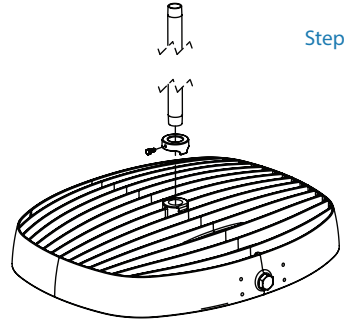

Step 3

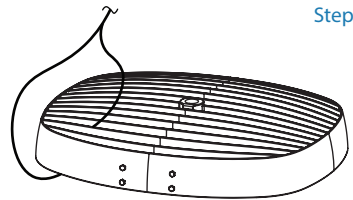

### WARNING:

For Class II, Division 2, Zone 22, and Class III hazardous locations, the AR head must not face upwards by any degree beyond the vertical position.

### ATTENTION:

Le luminaire (AR) ne doit pas être orientée vers le haut de quelque degré que ce soit au-delà de la position verticale pour les emplacements dangereux de Classe II, Division 2, Zone 22 et Classe III

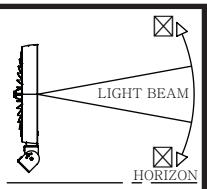

## AR-YK – HIGH VIBRATION YOKE INSTALLATION (Ordered Separately)

If using a different mounting accessory, refer to the corresponding page.

This AR-YK kit is intended for UL listed AR luminaires, as marked on the luminaire nameplate.

### Accessory Package Contents

| AR-YK | QTY | PART NAME                                |
|-------|-----|--|
|       | 1   | AR HIGH VIBRATION YOKE                   |
|       | 2   | CHEEK PLATE                              |
|       | 8   | M6 x 1 x 25mm SOCKET FLAT HEAD CAP SCREW |
|       | 4   | M6 FLAT WASHER                           |
|       | 4   | M6 x 1 x 16mm SOCKET HEAD CAP SCREW      |



## INSTALLATION STEPS

### STEP 1.

Inspect the shipping package and its contents to ensure no damage occurred during shipping.

### STEP 2.

Mount the AR high-vibration yoke to the mounting surface using a minimum of 4x ¼-20 or M6 fasteners (not provided).

### STEP 3.

Install a suitable wiring system to the conduit opening per CEC/NEC requirements for the specific location of the installation.

### NOTE:

To aid in assembly and protect against ingress, a petrolatum or soap-thickened mineral oil-based thread lubricant/sealant is necessary.

If the fixture has unused conduit openings, plug them to maintain the enclosure's integrity.

### STEP 4.

Mount AR cheek plates to sides of AR luminaire using 4x M6 flat head cap screws per side. Thread one cheek plate over installed wiring during assembly. Torque fasteners to 5 Nm (45 in-lbs).

### STEP 5.

Thread installed wiring through opening in AR high vibration yoke mount and install AR luminaire into yoke. The raised circular bosses on the AR cheek plates should register inside the large circular holes on the AR high-vibration yoke mount arms. Rotate the luminaire to aim in the desired direction and fasten it in place using 2x M6 socket head cap screws and flat washers per side. Torque fasteners to 5 Nm (45 in-lbs).

### STEP 6.

Continue installation with STEP 4 on PAGE 3.

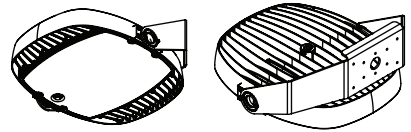

Step 2

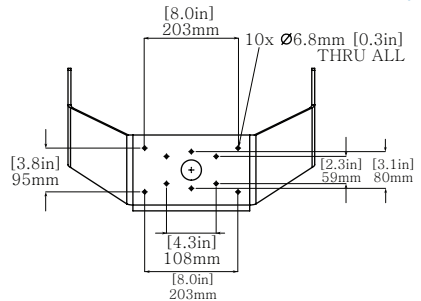

Step 4

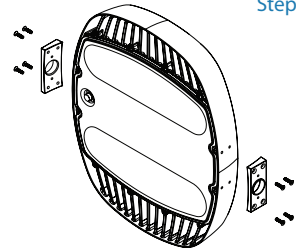

### WARNING:

For Class II, Division 2, Zone 22, and Class III hazardous locations, the AR head must not face upwards by any degree beyond the vertical position.

### ATTENTION:

Le luminaire (AR) ne doit pas être orientée vers le haut de quelque degré que ce soit au-delà de la position verticale pour les emplacements dangereux de Classe II, Division 2, Zone 22 et Classe III

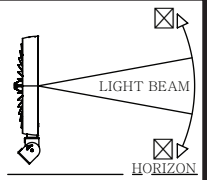

## AR-SFY – SLIP FITTER YOKE MOUNT (Ordered Separately)

If using a different mounting accessory, refer to the corresponding page.



**⚠ WARNING / ATTENTION**

Listing for Class II, Division 2, Zone 22, Class III, Nonrecessed Marine Luminaire and the IP66 or IP66/67 rating are limited to using the mount for mechanical support only and not part of the wiring system.

Luminaires marins de classe II, division 2, zone 22, classe III, non-encasté et la classification IP66 ou IP66 / 67 sont limitées à l'utilisation du support pour un support mécanique uniquement (l'entrée de conduit 3/4" NPT couverte par le support doit être branchée à l'aide des bouchons fournis). Il n'est pas autorisé à être utilisé pour le système de câblage.

This AR-SFY kit is intended for UL listed AR luminaires, as marked on the luminaire nameplate.

### Accessory Package Contents

| AR-SFY | QTY | PART NAME                                |
|--------|-----|--|
|        | 2   | M6 X 16mm FLAT HEX HEAD SOCKET CAP SCREW |
|        | 1   | SEALED CAP                               |
|        | 2   | M8 X 25mm SOCKET HEAD CAP SCREWS         |
|        | 6   | 3/8" HEX BOLTS                           |
|        | 4   | M6 X 16mm HEX HEAD CAP SCREW             |
|        | 1   | SLIP FITTER YOKE MOUNT (2x PIECES)       |
|        | 1   | CAP GASKET                               |

## INSTALLATION STEPS

### STEP 1.

Inspect shipping package and contents to ensure no damage has occurred during shipping.

### STEP 2.

Remove both M6 flat head cap screws using a 4mm hex key and remove the sealed cap. If the required angle is known, adjust the luminaire angle by loosening two M8 socket head cap screws inside the slip fitter pole mount using a 6mm hex key. After aiming torque, the M8 socket head cap screws to 17N-m (13ft-lb).

*NOTE: Aiming angle can be adjusted after Step 6.*

**WARNING:**  
For Class II, Division 2, Zone 22, and Class III hazardous locations, the AR head must not face upwards by any degree beyond the vertical position.

**ATTENTION:**  
Le luminaire (AR) ne doit pas être orientée vers le haut de quelque degré que ce soit au-delà de la position verticale pour les emplacements dangereux de Classe II, Division 2, Zone 22 et Classe III

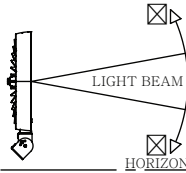

### STEP 3.

Install slip fitter pole mount onto the pole. Poles equivalent in size to 1-1/2" or 2" trade size pipe or conduit are to be used. Ensure the slip fitter pole mount is fully seated on top of the pole at the internal stops. Aim and secure slip fitter pole mount using the six provided 3/8" hex bolts. Torque to 20ft-lb.

### NOTE:

After installation, the aim can be adjusted up to 180° in either direction by loosening the 6 hex bolts and tightening again to 27 N-m (20 ft-lb). DO NOT TURN BEYOND 180°, as this will induce twist and strain on conductors after wiring.

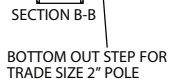
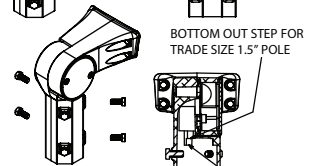
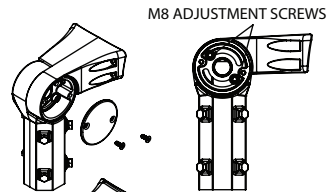
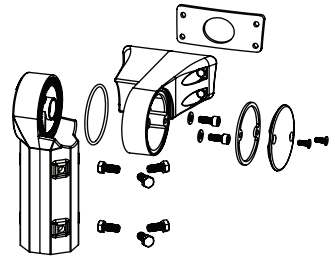
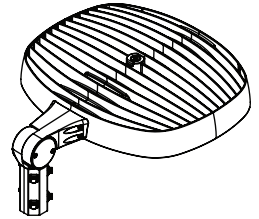

## AR-SFY – SLIP FITTER YOKE MOUNT (Ordered Separately)

If using a different mounting accessory, refer to the corresponding page.

Warning: Listing for Class II, Division 2, Zone 22, Class III, Nonrecessed Marine Luminaire and the IP66 or IP66/67 rating are Limited to using the mount for mechanical support only (¾" NPT Conduit entry covered by mount is to be plugged using provided plugs) and not part of the wiring system.

Luminaires marins de classe II, division 2, zone 22, classe III, non-encasté et la classification IP66 ou IP66/67 sont limitées à l'utilisation du support pour un support mécanique uniquement (l'entrée de conduit ¾" NPT couverte par le support doit être branchée à l'aide des bouchons fournis). Il n'est pas autorisé à être utilisé pour le système de câblage.

### INSTALLATION STEPS CONT.

#### STEP 4.

Install a suitable wiring system that complies with the wiring methods permitted in the Canadian Electrical Code or the National Electrical Code for the classification of the hazardous locations area of installation. Terminations are to be made inside the luminaire not inside the mount.

#### NOTE:

*This slip fitter pole mount is not permitted to be used for routing any wires as the conduit entry covered the mount is required to be plugged.*

#### STEP 5.

Ensure the wiring system has appropriate strain relief in the luminaire by tying a large enough knot using the supply field wiring in the wiring compartment such that it cannot be pulled through the 3/4" inch NPT entry of the luminaire.

#### STEP 6.

Secure slip fitter pole mount to luminaire with four M6 hex head cap screws provided using a 10mm socket. Torque to 7N-m (62in-lbs).

#### Step 7.

Close the sealed cap on the slip fitter pole mount. Torque to 7N-m (62in-lbs).

#### Step 8.

Follow the wiring instructions specified in the main installation instructions provided with the AR luminaire as applicable for making connections with the luminaire lead wires and testing the system (STEP 4 on PAGE 3).

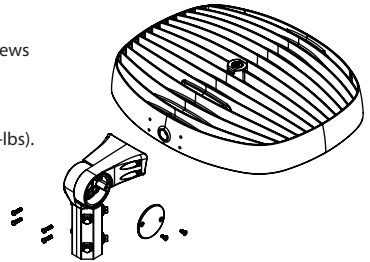
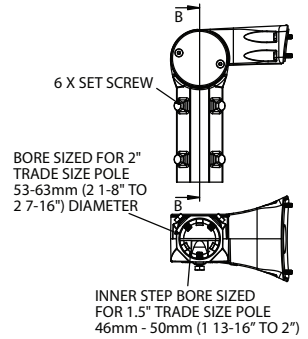

## AR-SFY-1.5 – THREADED ADJUSTABLE POLE MOUNT (Ordered Separately)

If using a different mounting accessory, refer to the corresponding page.

This AR-SFY-1.5 kit is intended for use with UL listed AR luminaire as marked on the luminaire nameplate.

### Accessory Package Contents

| AR-SFY-1.5 | QTY | PART NAME                                |
|------------|-----|--|
|            | 2   | M6 X 16mm FLAT HEX HEAD SOCKET CAP SCREW |
|            | 1   | SEALED CAP                               |
|            | 2   | M8 X 25mm SOCKET HEAD CAP SCREWS         |
|            | 4   | M6 X 16mm HEX HEAD CAP SCREW             |
|            | 1   | ADJUSTABLE POLE MOUNT (2x PIECES)        |
|            | 1   | CAP GASKET                               |
|            | 1   | 3/4" BUSHING                             |

## INSTALLATION STEPS

### STEP 1:

Inspect shipping package and contents to ensure no damage has occurred during shipping.

### STEP 2:

Install the provided plastic 3/4" bushing at the conduit entry used for supply connection to prevent wire abrasion.

### STEP 3:

**WARNING:** To reduce the risk of ignition of hazardous atmospheres, disconnect the luminaire from the supply circuit before opening. Keep tightly closed when in operation.

**ATTENTION:** Pour réduire le risque d'inflammation des atmosphères dangereuses, débranchez le luminaire du circuit électrique avant d'ouvrir. Conserver hermétiquement fermé lorsqu'il est en fonctionnement.

Remove both M6 flat head cap screws using a 4mm hex key and remove sealed cap. If required angle is known, adjust fixture angle by loosening two M8 socket head cap screws inside the mount using a 6mm hex key Torque to 17N-m (13ft-lb).

### NOTE:

Vertical angles can also be adjusted after step 6 via the two M8 socket head cap screws inside the mount.

### STEP 4:

Install adjustable pole mount and gasket with adhesive side applied to mount and attach to luminaire with included M6 bolts and washers. Torque to 7 N-m (62 in-lbs)

### STEP 5:

Thread mount assembly onto 1.5" NPT pole.

### NOTE:

To aid in assembly and provide protection against ingress, use of a petrolatum or soap thickened mineral oil based thread lubricant/sealant is necessary at the threads of the slip fitter pole mount.

### STEP 6:

Insert and tension M6 set screw to pole to lock rotation.

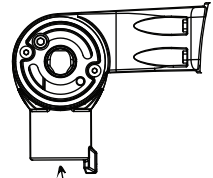

1.5" NPT THREADED ENTRY

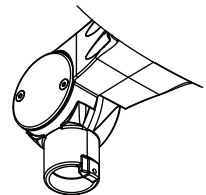
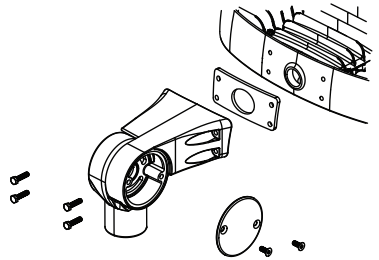

## AR-SFY-1.5 – THREADED ADJUSTABLE POLE MOUNT CONT. (Ordered Separately)

### INSTALLATION STEPS CONT.

#### STEP 7:

Install suitable wiring system that complies with the wiring methods acceptable for the specific location per the NEC and CEC. Terminations are to be made inside the luminaire not inside the mount.

Supply wires can be pulled through the center opening in mount and routed into the luminaire through the 3/4" bushing (installed before joining the luminaire to the mount).

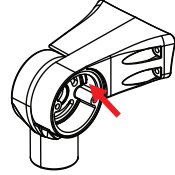

#### STEP 8:

Close sealed cap on SFY-1.5 Mount. Torque to 7 N-m (62in-lbs)

#### STEP 9:

Follow the wiring instructions specified in the surface/ceiling mount installation instructions section of this manual (STEP 4) for making connections with the luminaire lead wires and testing the system.

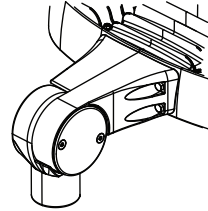



## AR-SP-AC – SURGE SUPPRESSOR KIT (Ordered Separately)

This AR-SP-AC kit is intended for UL listed AR luminaires, as marked on the luminaire nameplate.

### Accessory Package Contents

| AR-SP-AC | QTY | PART NAME                                |
|----------|-----|--|
|          | 1   | FSP3-277-20KA SURGE PROTECTOR            |
|          | 1   | 3M VHB TAPE                              |
|          | 1   | SURGE SUPPRESSOR RETENTION STRAP         |
|          | 2   | M3 x 8mm PAN HEAD PHILLIPS MACHINE SCREW |
|          | 2   | M3 FLAT WASHER                           |

- Protects against surges and transients per ANSI C62.41-2002 category C high (10KV, 1.2/50 $\mu$ S & 10KA, 8/20 $\mu$ S) standard Combo waves and (6KV, 100KHz) Ring wave

- Protects against surges and transients per new ANSI C82.77-5 2015 category C high (20KV, 1.2/50 $\mu$ S & 10KA, 8/20 $\mu$ S) standard Combo waves and (6KV, 100KHz) Ring wave.

## INSTALLATION STEPS

### STEP 1.

Inspect shipping package and contents to ensure no damage has occurred during shipping.

### STEP 2.

Open AR lens with 7mm hex socket driver. Allow the lens to hang via the retention strap.

### NOTE:

*Screws are captive and will remain attached to the lens for ease of reinstall and to prevent loss of fasteners.*

### STEP 3.

Install the double-sided tape provided along the side of the surge protector. Remove the backing paper and place it between the mounting points as shown, tape-side down. Install the retention strap with two M3 fasteners and ensure the surge protector is held tightly in place.

### STEP 4.

Wire according to wiring instructions on page 2. Refer to NEC/CEC codes and follow all applicable local standards.

### STEP 5.

Close the AR lens. Ensure the retention cable is not pinched between the AR head and the AR lens. Tighten the lens bolts using a 7mm socket or box wrench to 1.7 N-m (15 in-lbs) in the order designated in the diagram to ensure gasket sealing.

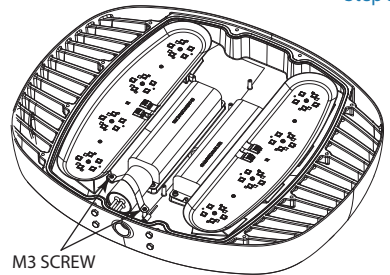
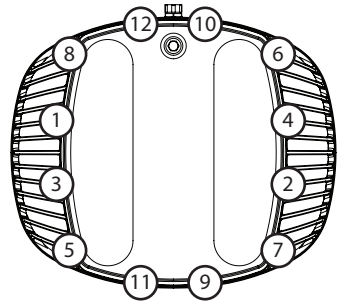
**Step 3**

**Step 5**

## WIRING DIAGRAM

(AR-SP-AC)

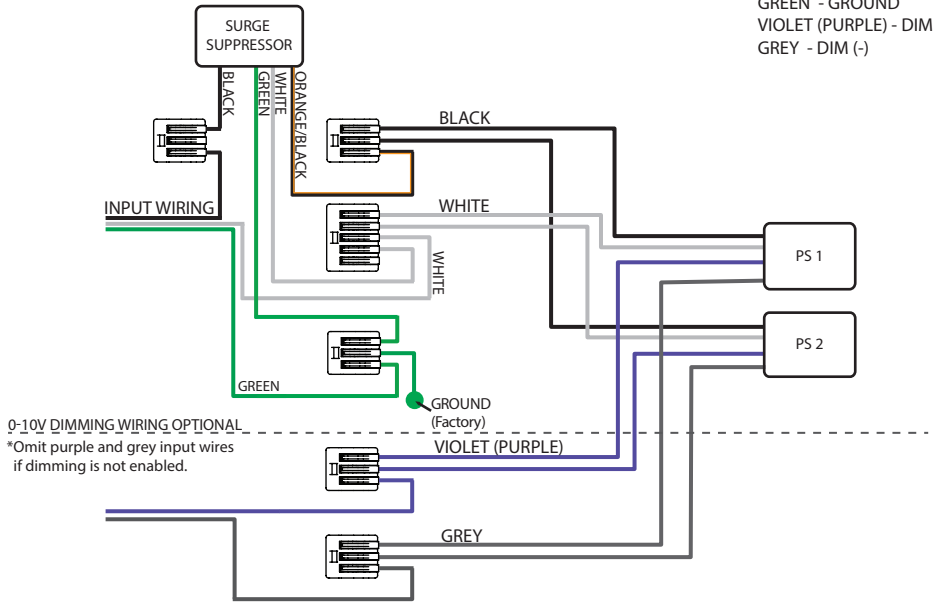
BLACK - LINE  
WHITE - NEUTRAL/LINE 2  
GREEN - GROUND  
VIOLET (PURPLE) - DIM (+)  
GREY - DIM (-)



1. Disconnect the line input branch circuit conductor from the splice or terminal connected to the Black leads from the LED driver. Reconnect the line Input branch circuit conductor to the Black wire from the surge protector.
2. Connect the Orange/Black wire from the surge protector to the splice or terminal connected to the Black leads from the LED drivers.
3. Connect the White lead from the surge protector to the splice or terminal connected to the neutral input branch circuit conductor and the White leads from the LED drivers.
4. Connect the Green wire from the surge protector to the splice or terminal connected to the Grounding branch circuit conductor and the Green lead from the luminaire case.

## AR-SP-HV – SURGE SUPPRESSOR KIT (Ordered Separately)

This AR-SP-HV kit is intended for use with UL listed AR luminaire, as marked on the luminaire nameplate.

### Accessory Package Contents

| AR-SP-HV | QTY | PART NAME                                |
|----------|-----|--|
|          | 1   | FSP3-480-20KA SURGE PROTECTOR            |
|          | 1   | 3M VHB TAPE                              |
|          | 1   | SURGE SUPPRESSOR RETENTION STRAP         |
|          | 2   | M3 x 8mm PAN HEAD PHILLIPS MACHINE SCREW |
|          | 2   | M3 FLAT WASHER                           |

- Protects against surges and transients per ANSI C62.41-2002 category C high (10KV, 1.2/50µS & 10KA, 8/20µS) standard Combo waves and (6KV, 100KHz) Ring wave.

- Protects against surges and transients per new ANSI C82.77-5 2015 category C high (20KV, 1.2/50µS & 10KA, 8/20µS) standard Combo waves and (6KV, 100KHz) Ring wave.

### INSTALLATION STEPS

#### STEP 1.

Inspect shipping package and contents to ensure no damage has occurred during shipping.

#### STEP 2.

Open AR lens with 7mm hex socket driver. Allow lens to hang via retention strap.

#### NOTE:

*Screws are captive and will remain attached to the lens for ease of reinstall and to prevent loss of fasteners.*

#### STEP 3.

Install provided double-sided tape along the side of the surge protector. Remove the backing paper and place it between the mounting points as shown, tape-side down. Install the retention strap with two M3 fasteners and ensure the surge protector is held tightly in place.

#### STEP 4.

Wire according to wiring instructions on page 2. Refer to NEC/CEC codes and follow all applicable local standards.

#### STEP 5.

Close the AR lens. Ensure the retention cable is not pinched between the AR head and the AR lens. Tighten the lens bolts using a 7mm socket or box wrench to 1.7 N-m (15 in-lbs) in the order designated in the diagram to maintain ideal gasket sealing.

Step 3

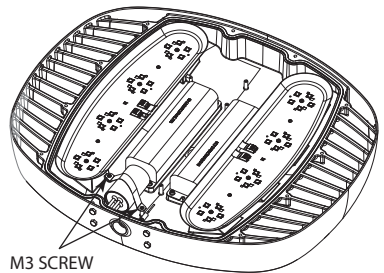

Step 5

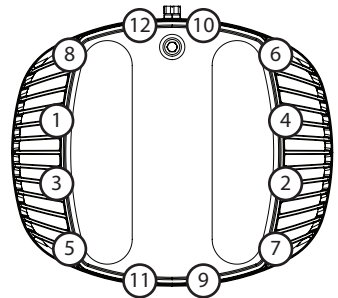

## WIRING DIAGRAM

(AR-SP-HV)

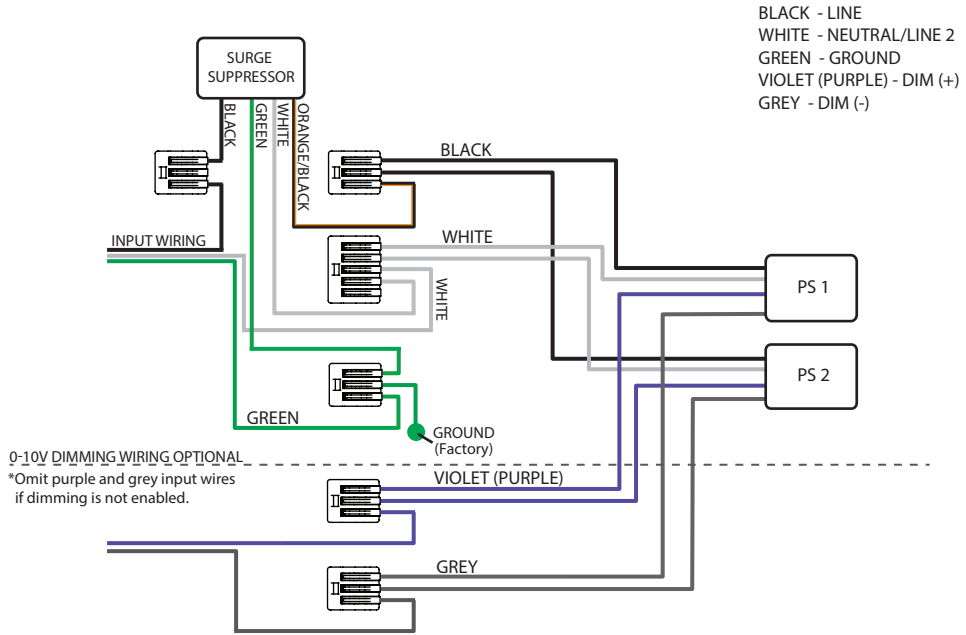

1. Disconnect the line input branch circuit conductor from the splice or terminal connected to the Black leads from the LED driver. Reconnect the line input branch circuit conductor to the Black wire from the surge protector.
2. Connect the Orange/Black wire from the surge protector to the splice or terminal connected to the Black leads from the LED drivers.
3. Connect the White lead from the surge protector to the splice or terminal connected to the neutral input branch circuit conductor and the White leads from the LED drivers.
4. Connect the Green wire from the surge protector to the splice or terminal connected to the grounding branch circuit conductor and the green lead from the luminaire case.

## AR-SK-## – SECONDARY SAFETY KIT (Ordered Separately)

This AR-SK-## kit is intended for use with UL listed AR luminaire, as marked on the luminaire nameplate.

### Accessory Package Contents

| AR-SK-## | QTY | PART NAME                              |
|----------|-----|--|
|          | 1   | 1003-01-02-301 (ZLM SCONDARY SAFETY)   |
|          | 1   | M6 FLAT WASHER                         |
|          | 1   | M6 x 20mm HEX CAP SCREW                |
|          | 2   | OVAL SHAPED THREADED CONNECTING LINK   |
|          | 1   | STAINLESS STEEL CHAIN, 1/8" TRADE SIZE |

## INSTALLATION STEPS

### STEP 1.

Remove the bottom-left pre-installed M6 x 16mm Hex Cap Screw.

### STEP 2.

Install bracket on AR luminaire as shown using supplied M6 x 20mm hex cap screw. Torque M6 x 20mm hex cap screw to 40 in-lbs (4.5 Nm). It is strongly recommended that a medium or high strength thread-locker be used when installing the bracket. For units using surface or suspension mounting, install safety kit hardware on top of the surface mount or suspension mount brackets in the same location as shown.

### STEP 3.

Attach stainless steel chain to safety kit bracket using stainless steel oval shaped threaded connecting link.

### STEP 4.

Attach the loose end of the chain. The secondary safety mounting point must be suitable for supporting a minimum of 180 lbs:

- Attach the loose end of the stainless steel chain to the fixed eye bolt (not supplied) using the second stainless steel oval-shaped threaded connecting link.
- Alternate attachment method: Wrap the loose end of the chain around a fixed beam or other immovable support and create a closed loop using the second stainless steel oval-shaped threaded connecting link. The supporting beam or structure must form a closed loop to prevent the secondary safety chain from slipping off or becoming unhooked.

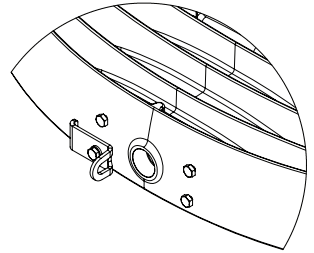

Step 1

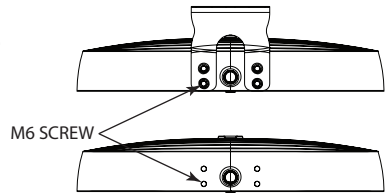

Step 2

