

# BL Series Installation Manual

## IP68 | Encapsulated Variant



### APPLICATION

The BL-EN luminaire is an industrial-grade LED product suitable for use in areas subject to extended or continuous submersion, requiring IP68 ingress protection. The BL Series is also certified for use on marine vessels inside, outside and in other severely wet saltwater environments. This product family is commonly exposed to moisture, dirt, corrosion, vibration, and rough usage. Models, including "–EN–," are approved for submersion areas.

UL File Number: E477827

BL luminaires are suitable for use in the following areas as defined by the National Electrical Code (NEC) and the Canadian Electrical Code (CEC):

Standards that apply to all models:

UL 1598 and UL 1598A;  
CSA C22.2 No. 250.0-18 and CSA C22.2 No. 250.13-17

Housing:

Copper-free die cast aluminum with polycarbonate lens.  
Optional glass window in stainless frame.

Input Voltage:

AC: 120/230-277VAC 50/60Hz  
HV: 347VAC 50/60Hz

Rated Wattage:

BL20: 17.5W | BL40: 37W

Inrush Current:

BL(EN-AC): Peak / >10% 120V: 18A / 304uS Duration 277V: 43A / 278uS  
BL(EN-HV): Peak / >50% Duration 347V: 3.5A/200uS

Connections:

Standard 10ft 18/3 SOOW  
Dimming 10ft 18/5 SOOW  
Refer to wiring diagrams for connections.  
Class 1 wiring only

Temperature Range:

-50°C to +65°C

Ingress Protection:

IP68 Continuous submersion 25ft | Suitable for wet locations. |  
Marine outside type (salt water)

## INSTALLATION STEPS

The Luminaire shall be installed per one of the following mounting means shipped with the luminaire.

Mount fixture in desired location  
 (refer to desired mounting section below).



### WARNING/ ATTENTION

**WARNING:** THIS PRODUCT MUST BE INSTALLED IN ACCORDANCE WITH THE APPLICABLE INSTALLATION CODE BY A PERSON FAMILIAR WITH THE CONSTRUCTION AND OPERATION OF THE PRODUCT AND THE HAZARDS INVOLVED.

**ATTENTION:** CE PRODUIT DOIT ÊTRE INSTALLÉ SELON LE CODE D'INSTALLATION PERTINENT, PAR UNE PERSONNE QUI CONNAÎT BIEN LE PRODUIT ET SON FONCTIONNEMENT AINSI QUE LES RISQUES INHÉRENTS.

## BL-SM – SURFACE/CEILING MOUNT INSTALLATION (Ordered Separately)

*If using a different mounting accessory, refer to the corresponding page.*

This BL-SM kit is intended for use with UL listed BL luminaire, as marked on the luminaire nameplate.

### Accessory Package Contents

BL-SM	QTY	PART NAME
	2	SURFACE/SUSPENSION MOUNT BRACKET
	4	M6 X 12mm HEX HEAD CAP SCREW
	4	M6 FLAT WASHER



## INSTALLATION STEPS

**WARNING:**  
 Suspension mounting has not been evaluated for use in hazardous locations.

**ATTENTION:**  
 Le montage de la suspension n'a pas été évalué pour une utilisation dans des zones dangereuses.

**STEP 1.**  
 Inspect shipping package and contents to ensure no damage has occurred during shipping.

**STEP 2.**  
 The BL-SM kit is required for surface mounting. Install surface mounting brackets on the BL luminaire as shown using the provided M6 fasteners. Torque the M6 fasteners to 4.5 N-m [40 in-lbs]. For surface installation, mount the fixture to the desired location using 4x ¼-20 or M6 fasteners.

**STEP 3.**  
 Continue installation with STEP 3 on PAGE 3.

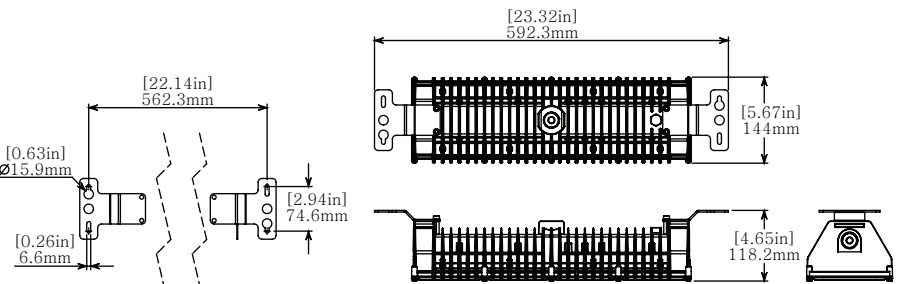
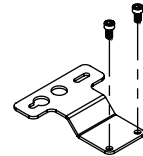
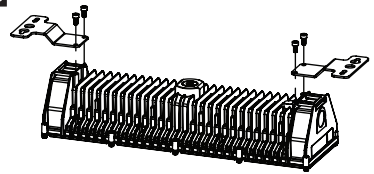

## BL-WM – WALL MOUNT INSTALLATION (Ordered Separately)

*If using a different mounting accessory, refer to the corresponding page.*

This BL-WM kit is intended for use with UL listed BL luminaire, as marked on the luminaire nameplate.

### Accessory Package Contents

BL-WM	QTY	PART NAME
	2	WALL MOUNT BRACKET
	4	M6 X 12mm HEX HEAD CAP SCREW
	4	M6 FLAT WASHER



## INSTALLATION STEPS

### STEP 1.

Inspect shipping package and contents to ensure no damage has occurred during shipping.

### STEP 2.

The BL-WM kit is required for wall mounting. Install wall mounting brackets on the BL luminaire as shown using the provided M6 fasteners. Torque the M6 fasteners to 4.5 N-m [40 in-lbs]. Mount the fixture to the desired location using 4x ¼-20 or M6 fasteners.

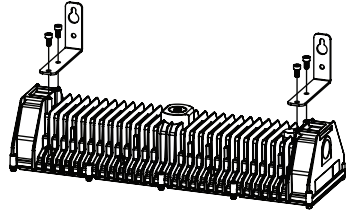

### STEP 3.

Continue installation with STEP 3 on PAGE 3.

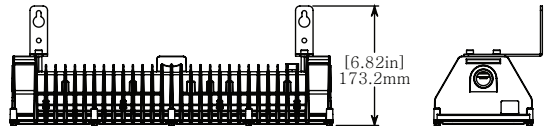
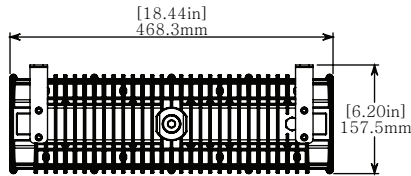
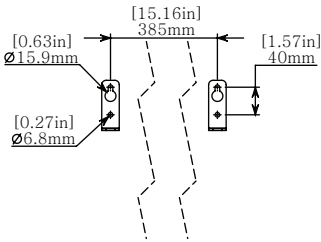

## BL-YM – YOKE MOUNT INSTALLATION (Ordered Separately)

If using a different mounting accessory, refer to the corresponding page.

This BL-YM kit is intended for UL listed BL luminaires, as marked on the luminaire nameplate.

### Accessory Package Contents

BL-YM	QTY	PART NAME
	2	SWIVEL BRACKET A
	2	SWIVEL BRACKET B
	4	M6 x 1 x 12mm SOCKET HEAD CAP SCREW
	4	M4 x 8mm SOCKET HEAD CAP SCREW

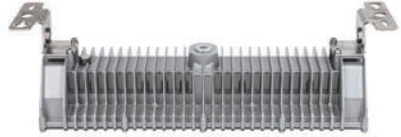

## INSTALLATION STEPS

### STEP 1.

Inspect shipping package and contents to ensure no damage has occurred during shipping.

### STEP 2.

The BL-YM kit is required for adjustable/swivel bracket mounting. Install swivel bracket A components on the BL luminaire using the M6 fasteners. Torque the M6 fasteners to 4.5 N-m [40 in-lbs]. Install swivel bracket B components on the BL luminaire using the M4 fasteners. Torque the M4 fasteners to 1.7 N-m [15 in-lbs]. Mount the fixture to the desired location using 4x ¼-20 or M6 fasteners.

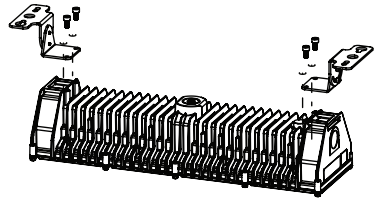

### STEP 3.

Continue installation with STEP 3 on PAGE 3.

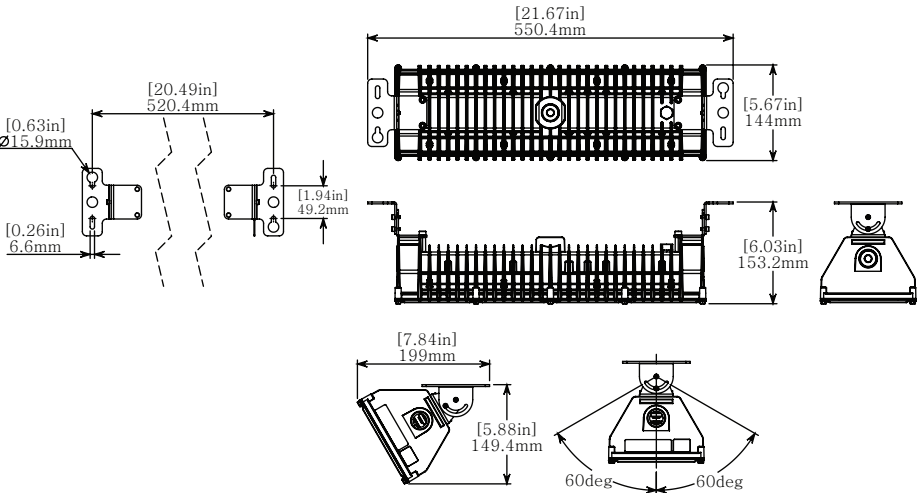
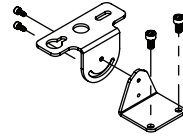

## BL-HK – HOOK PENDANT INSTALLATION (Ordered Separately)

*If using a different mounting accessory, refer to the corresponding page.*

This BL-HK kit is intended for UL listed BL luminaires, as marked on the luminaire nameplate.

### Accessory Package Contents

BL-HK	QTY	PART NAME
	1	PENDANT HOOK ASSEMBLY
	1	ANTI-ROTATION ASSEMBLY

## INSTALLATION STEPS

### STEP 1.

Inspect shipping package and contents to ensure no damage has occurred during shipping.

### STEP 2.

The BL-HK kit is required for hook pendant installation. Slide anti-rotation lock onto suspension hook assembly and install hook assembly into 3/4" NPT threaded entry. Tighten to hand tight plus 1 to 2 turns. Slide the anti-rotation lock into place and tighten the set screw to lock the unit in place. Tighten the anti-rotation lock set screw to 4.5 N-m [40 in-lbs]. Clip hook onto eye-bolt or other fixed mounting loop.

### STEP 3.

Continue installation with STEP 3 on PAGE 3.

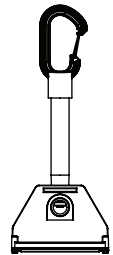
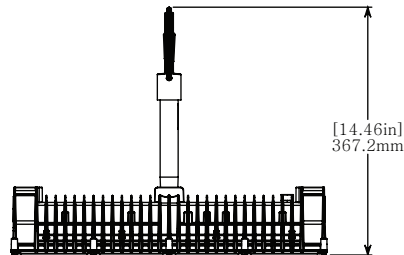
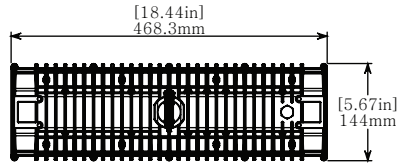
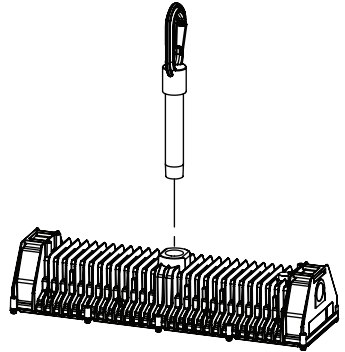

## BL-TC – TUBE CLAMP MOUNT INSTALLATION (Ordered Separately)

If using a different mounting accessory, refer to the corresponding page.

This BL-TC kit is intended for use with UL listed BL luminaire, as marked on the luminaire nameplate.

### Accessory Package Contents

BL-TC	QTY	PART NAME
	2	TOP CLAMP MOUNT BRACKET
	2	BOTTOM CLAMP MOUNT BRACKET
	4	M6 X 12mm HEX HEAD CAP SCREW



## INSTALLATION STEPS

### STEP 1.

Inspect shipping package and contents to ensure no damage has occurred during shipping.

### STEP 2.

The BL-TC kit is required for mounting onto tubing between 24.0mm [0.95in] and 32.0mm [1.26in] in diameter. Install the Tube Mount components as shown using the provided fasteners. Tighten M6 fasteners by equal amounts until they make contact with the tubing. Torque to a maximum of 4.5 N-m [40 in-lbs] to secure the luminaire.

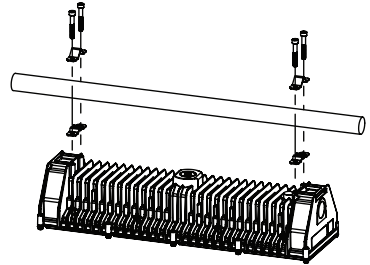

### STEP 3.

Continue installation with STEP 3 on PAGE 3.

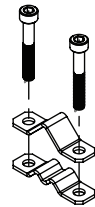
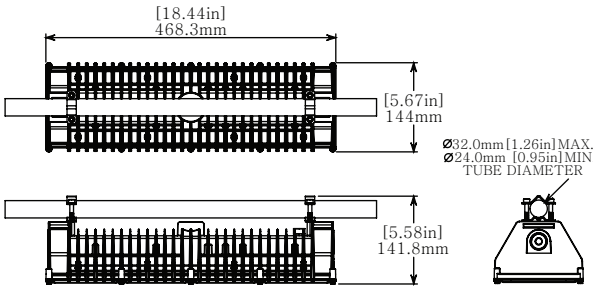

## BL-ST5## - STRAP MOUNT INSTALLATION (Ordered Separately)

If using a different mounting accessory, refer to the corresponding page.

This BL-ST5## kit is intended for use with UL listed BL luminaire, as marked on the luminaire nameplate.

### Accessory Package Contents

BL-ST5##	QTY	PART NAME
	##	STRAP MOUNT BRACKET
	4	6 x 25mm SOCKET HEAD CAP SCREW

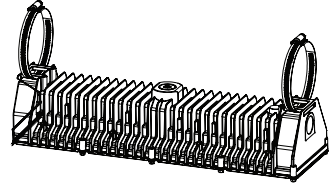

## INSTALLATION STEPS

### STEP 1.

Inspect shipping package and contents to ensure no damage has occurred during shipping.

### STEP 2.

For strap mounting onto structural elements, install supplied straps through the slots at the ends of the luminaire and around the mounting point. Feed the open end through the worm drive and tighten the screw to secure the luminaire.

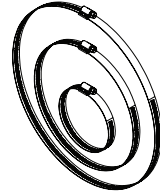

### STEP 3.

Continue installation with STEP 3 on PAGE 3.

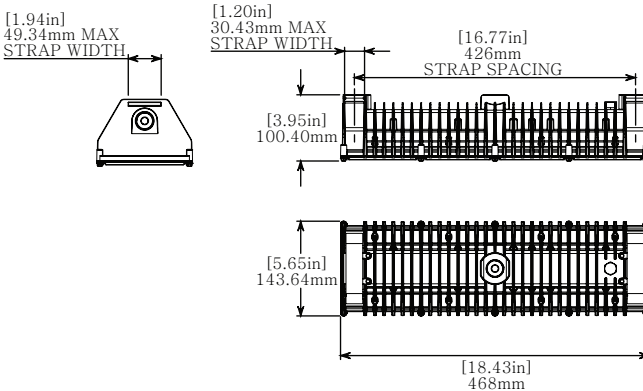

P/N	QTY	DESCRIPTION
ST512	2	Stainless steel tube clamp, fits 9 3/8" to 12" tubing diameter
ST59	2	Stainless steel tube clamp, fits 7 1/8" to 9 3/4" tubing diameter
ST58	2	Stainless steel tube clamp, fits 5 5/8" to 8 1/4" tubing diameter
ST56	2	Stainless steel tube clamp, fits 4 1/8" to 6 3/4" tubing diameter
ST55	2	Stainless steel tube clamp, fits 3 5/8" to 6 1/4" tubing diameter
ST54	2	Stainless steel tube clamp, fits 3 5/16" to 4 1/4" tubing diameter
ST53	2	Stainless steel tube clamp, fits 2 9/16" to 3 1/4" tubing diameter