

JR Series Installation Manual



APPLICATION

The JR luminaire is an industrial-grade product suitable for harsh and hazardous locations. Installation areas include indoor, outdoor, and wet locations. Frequent exposure to moisture, dirt, corrosion, vibration, and rough usage is common for this product family. Furthermore, the JR fixtures have certifications for use on marine vessels inside, outside, and in other severely wet saltwater environments. Part numbers containing "-HZ-" are approved for use in hazardous locations.

JR luminaires are suitable for use in the following areas as defined by the National Electrical Code (NEC) and the Canadian Electrical Code (CEC):

LC File Numbers:	Nemalux General Location: LC22294-1 Nemalux Hazardous Location: LC22294-1
Standards that apply to all models:	UL844, UL 1598, UL 1598A and UL 8750; CSA C22.2 No. 250.0 and CSA C22.2 No. 250.13
Standards that apply only to Hazardous Location models (JRX-XXX-XXX-XX-HZ-XX):	UL 844, CSA C22.2 No. 137
Hazardous Location Certification:	Class I, Division 2, Groups ABCD T3; Class II, Division 1, Groups FG T3; Class III, Division 1 and Division 2
Housing:	Copper-free high pressure die-cast aluminum housing, glass or polycarbonate protective lens, stainless steel fasteners
Input Voltage:	Based on luminaire suffix in table below: Suffix - AC: 120-277 VAC Suffix - HV: 347 VAC (general location only)
Ambient Temperature Range:	-40°C to +60°C
Connections:	3 x 3/4" NPT Conduit Black: Line White: Neutral/Line 2 Green: Ground <i>Optional: Violet (Purple): 0-10V Dimming (+) Grey: 0-10V Dimming (-)</i> For connections use wire rated to a minimum of 90°C. Class 1 wiring only. All supply field wiring must be rated 300V minimum for luminaires with suffix AC, 600V minimum for luminaires with suffix HV.
Ingress Protection:	IP66/67 Suitable for wet locations. Marine outside type (salt water).

APPLICATION Cont.

Electrical Ratings & Optic Options

— Vertical Plane 0-180°
 - - - Vertical Plane 90-270°
 — Max Horizontal Plane

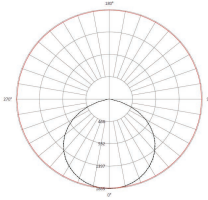

GWC - Wide Beam (No Optics)

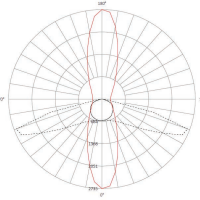

GT1 - IESNA Type 1

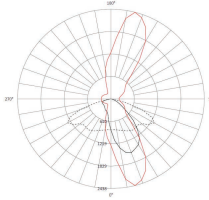

GT2 - IESNA Type 2

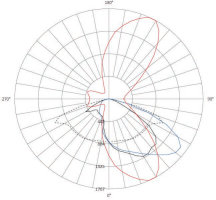

GT3 - IESNA Type 3

AC MODELS (5000K CCT, minimum)

MODEL	LUMENS	WATTS	LUMENS/WATT	MODEL	LUMENS	WATTS	LUMENS/WATT	MODEL	LUMENS	WATTS	LUMENS/WATT	MODEL	LUMENS	WATTS	LUMENS/WATT
JR2	2,874	18	164	JR2	2,033	19	107	JR2	2,084	19	110	JR2	2,091	19	110
JR4	5,227	36	144	JR4	3,609	38	95	JR4	3,700	38	97	JR4	3,613	37	95

Note: Standard offering above, alternate optical profiles available upon request.
 Contact Nemalux Sales representative for further details. Minimum order quantities, additional costs and lead times may be applicable.



WARNING / ATTENTION

To avoid the risk of fire, explosion, or electric shock, this product should be installed, inspected, and maintained by a qualified electrician only, in accordance with all applicable electrical codes.

Éviter tout risque d'incendie, d'explosion ou d'électrocution, ce produit doit être installé, inspecté et entretenu par un électricien qualifié uniquement, conformément à tous codes électriques applicables.



WARNING / ATTENTION

To reduce the risk of electric shock, disconnect the luminaire from the supply circuit before opening for installation and servicing. Keep tightly closed when in operation.

Pour réduire le risque de choc électrique, débranchez le luminaire du circuit d'alimentation avant l'ouverture pour l'installation et entretien. Gardez hermétiquement fermé pendant le fonctionnement.



WARNING ATTENTION Potential Electrostatic Charging Hazard Risque potentiel de charge électrostatique

Avoid electrostatic discharge:

- Clean exterior lens surface with damp cloth only
- Éviter les décharges électrostatiques: nettoyer la surface extérieure de la lentille uniquement avec un chiffon humide

JR-SM – SURFACE/CEILING MOUNT INSTALLATION (Ordered Separately)

If using a different mounting accessory, refer to the corresponding page.

This JR-SM kit is intended for LC-listed JR luminaires, as marked on the luminaire nameplate.

Accessory Package Contents

JR-SM	QTY	PART NAME
	2	SURFACE/SUSPENSION MOUNT BRACKET
	4	M6 X 12mm SOCKET HEAD CAP SCREW
	4	M6 FLAT WASHER



INSTALLATION STEPS

STEP 1.

Inspect shipping package and contents to ensure no damage has occurred during shipping.

STEP 2.

Install surface/suspension mount brackets using the 4x M6 hex cap bracket mounting screws. See the diagram for the orientation of brackets. Torque M6 bolts to 5 Nm (45 in-lbs).

STEP 3.

For a surface mounting configuration, mount the luminaire in the desired locations using 4x 1/4-20 OR 4x M6 fasteners and washers (not provided).

STEP 4.

Open the JR wiring cover and allow the cover to hang via the retention strap.

STEP 5.

Open the JR wiring cover and allow the cover to hang via retention strap.

Note:

Screws are captive and will remain attached to the lens for ease of reinstall and to prevent loss of fasteners.

STEP 6.

For convenience spring cage wire connectors have been provided. 12-28AWG solid or stranded wire with a strip length of 8-10mm (0.35-0.39") is supported. The connectors may be replaced by an alternate listed connector if user wiring requires it.

Step 1-3

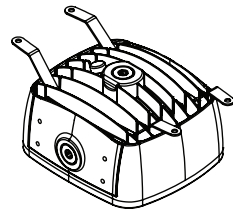
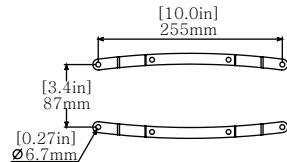
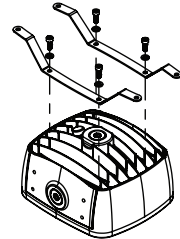

JR-SM – SURFACE/CEILING MOUNT INSTALLATION CONT. INSTALLATION STEPS CONT.

STEP 6. Cont.

Make wiring connections from branch circuit conductors to factory provided lead wires using one of the 3/4" NPT threaded entries. Follow wiring method requirements of the Canadian Electrical Code or National Electrical Code for the specific location of the installation. If installing a hazardous location model (JRX-XXX-XXX-XX-HZ-XX) in a hazardous location, follow the hazardous location wiring method requirements of the Canadian Electrical Code or National Electrical Code.

For 0-10V Analog Dimming Control:
Ensure dimming control is certified and suitable for the classification of the area of installation. Connect Violet (Purple) (+) and Gray (-), driver lead wires, to 0-10VDC control wiring. 0-10V Controller must sink current from LED driver - LED drivers will source a combined maximum of 200uA for control needs.

NOTE:

The use of a petrolatum or soap-thickened mineral oil-based thread lubricant/sealant is necessary to aid in assembly and provide protection against ingress.

If the fixture has unused conduit openings, plug them to maintain the enclosure's integrity.

STEP 7.

Close the JR cover. Ensure the retention cable is not pinched between the JR head and the JR cover. Tighten the cover bolts to 1.7 N-m (15 in-lbs).

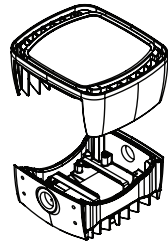
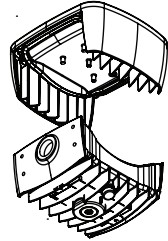
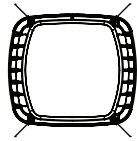

WIRING DIAGRAM

BLACK - LINE
WHITE - NEUTRAL/LINE 2
GREEN - GROUND
VIOLET (PURPLE) A- DIM (+)*
GREY - DIM (-)*

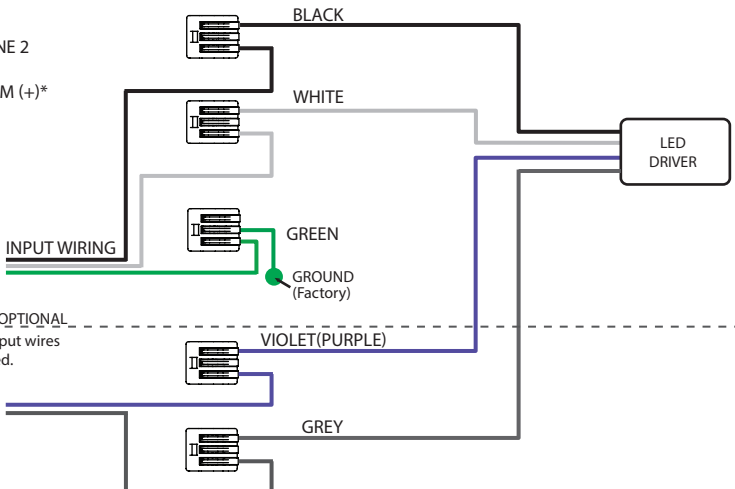

JR-PM – POLE MOUNT INSTALLATION (Ordered Separately)

If using a different mounting accessory, refer to the corresponding page.

This JR-PM kit is intended for LC-listed JR luminaires, as marked on the luminaire nameplate.

Accessory Package Contents

JR-PM	QTY	PART NAME
	1	POLE MOUNT
	1	POLE MOUNT GASKET
	4	M6 X 25mm HEX HEAD CAP SCREW
	4	M6 FLAT WASHER
	1	M6 X 16mm HEX HEAD CAP SCREW
	1	3/4 NPT THREADED SMOOTH BORE BUSHING



INSTALLATION STEPS

STEP 1.

Inspect shipping package and contents to ensure no damage has occurred during shipping.

STEP 2.

Install the provided plastic 3/4" bushing into side 3/4" NPT entry.

STEP 3.

Install pole mount and gasket with adhesive side applied to mount using included M6 bolts and washers. Torque to 5 Nm (45 in-lbs).

STEP 4.

Thread luminaire assembly onto 1.5" NPT pole.

NOTE:

The use of a petrolatum or soap-thickened mineral oil-based thread lubricant/sealant is necessary to aid in assembly and provide protection against ingress.

If the fixture has unused conduit openings, plug them to maintain the enclosure's integrity.

STEP 5.

Insert and tension M6 set screw to pole to lock rotation.

STEP 6.

Continue installation with STEP 4 on PAGE 3.

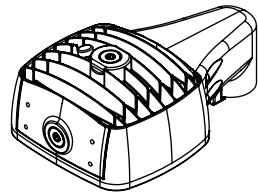
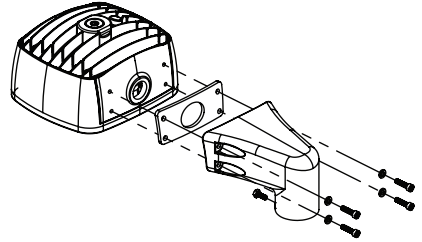

JR-WM2 – WALL MOUNT 2 INSTALLATION (Ordered Separately)

If using a different mounting accessory, refer to the corresponding page.

This JR-WM2 kit is intended for LC-listed JR luminaires, as marked on the luminaire nameplate.

Accessory Package Contents

JR-WM2	QTY	PART NAME
	1	WALL MOUNT
	1	WALL MOUNT LID
	1	WALL MOUNT GASKET
	4	6 x 25mm SOCKET HEAD CAP SCREW
	2	M6 x 20mm SOCKET HEAD CAP SCREW
	4	M6 FLAT WASHER
	3	3/4 NPT HEX CAP PLUG
	1	3/4 NPT THREADED SMOOTH BORE BUSHING
	1	WIRE EXTENSION KIT



INSTALLATION STEPS

STEP 1.

Inspect shipping package and contents to ensure no damage has occurred during shipping.

STEP 2.

Install provided 3/4" NPT conduit plugs in desired locations on wall mount. To maintain ingress rating all NPT entries not used for wiring connections are required to be plugged. Torque to 10 Nm (88 in-lbs).

NOTE:

The use of a petrolatum or soap-thickened mineral oil-based thread lubricant/sealant is necessary to aid in assembly and provide protection against ingress.

If the fixture has unused conduit openings, plug them to maintain the enclosure's integrity.

STEP 3.

Open JR luminaire by removing cover bolts. Note screws are captive for easy reinstallation. Install provided 3/4" smooth bore bushing in side NPT entry. Extend supply wires through bushing with provided wire extensions. Close JR & torque fasteners to 1.7 N-m (15 in-lbs).

STEP 4.

Attach gasket to WM2 cover face and then fasten to JR body with the provided M6 screws and washers. Torque to 5N-m (45in-lbs).

STEP 5.

Mount WM2 base in desired location through the 4 10mm (3/8") mounting holes using appropriate fasteners and washers for the supporting material (fasteners not provided).

STEP 6.

Route branch conductors to WM2 base. Follow wiring method requirements of the Canadian Electrical Code or National Electrical Code for the specific location of the installation. If installing a hazardous location model (JRXX-XXX-XXX-XX-HZ-XX) in a hazardous location, follow the hazardous location wiring method requirements of the Canadian Electrical Code or National Electrical Code.

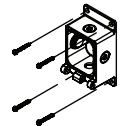
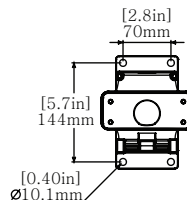
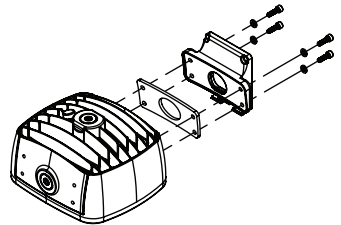
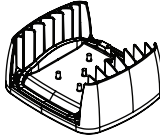
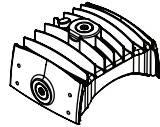
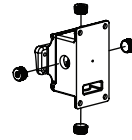

JR-WM2 – WALL MOUNT 2 INSTALLATION CONT.

INSTALLATION STEPS CONT.

Step 7.

Hang JR luminaire/WM2 cover over hinge pins in preparation for wiring.

Step 8.

Make wiring connections from luminaire wires branch circuit conductors, ensuring bonding connection with WM2 base (wiring diagram on pg 4). Follow wiring method requirements of the Canadian Electrical Code or National Electrical Code for the specific location of the installation. If installing a hazardous location model (JRXX-XXX-XXX-XX-HZ-XX) in a hazardous location, follow the hazardous location wiring method requirements of the Canadian Electrical Code or National Electrical Code.

For 0-10V analog dimming control ensure dimming control is certified and suitable for the classification of the area of installation. Connect Violet (Purple) (+) and Gray (-), driver lead wires, to 0-10VDC control wiring. LED drivers will source a combined maximum of 200µA for control needs.

0-10V controller must sink current from LED driver - LED drivers will source a combined maximum of 200uA for control needs.

Step 9.

Swing JR-WM2 cover upward closing the junction box. Care required to ensure no wires are pinched between lid and body. Secure lid to body with two provided M6 fasteners.

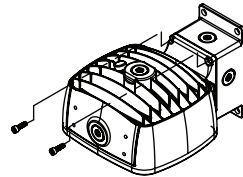
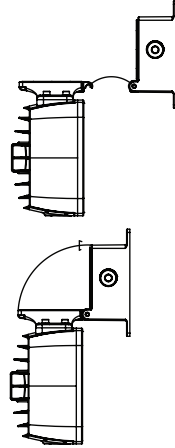

JR-YK – HIGH VIBRATION YOKE INSTALLATION (Ordered Separately)

If using a different mounting accessory, refer to the corresponding page.

This JR-YK kit is intended for LC-listed JR luminaires, as marked on the luminaire nameplate.

Accessory Package Contents

JR-YK	QTY	PART NAME
	1	JR HIGH VIBRATION YOKE
	2	CHEEK PLATE
	8	M6 x 1 x 25mm SOCKET FLAT HEAD CAP SCREW
	4	M6 FLAT WASHER
	4	M6 x 1 x 16mm SOCKET HEAD CAP SCREW



INSTALLATION STEPS

STEP 1.

Inspect shipping package and contents to ensure no damage has occurred during shipping.

STEP 2.

Mount JR high vibration yoke to mounting surface using a minimum of 4x ¼-20 or M6 fasteners (not provided).

STEP 3.

Make wiring connections from branch circuit conductors to factory provided lead wires using one of the 3/4" NPT threaded entries. Follow wiring method requirements of the Canadian Electrical Code or National Electrical Code for the specific location of the installation. If installing a hazardous location model (JRXX-XXX-XXX-XX-HZ-XX) in a hazardous location, follow the hazardous location wiring method requirements of the Canadian Electrical Code or National Electrical Code.

NOTE:

The use of a petrolatum or soap-thickened mineral oil-based thread lubricant/sealant is necessary to aid in assembly and provide protection against ingress.

If the fixture has unused conduit openings, plug them to maintain the enclosure's integrity.

STEP 4.

Mount JR cheek plates to sides of JR luminaire using 4x M6 flat head cap screws per side. Thread one cheek plate over installed wiring during assembly. Torque fasteners to 5 Nm (45 in-lbs).

STEP 5.

Thread installed wiring through opening in JR high vibration yoke mount and install JR luminaire into yoke. The raised circular bosses on the JR cheek plates should register inside of the large circular holes on the JR high vibration yoke mount arms. Rotate luminaire to aim in the desired direction and fasten in place using 2x M6 socket head cap screws and flat washers per side. Torque fasteners to 5 Nm (45 in-lbs).

STEP 6.

Continue installation with STEP 4 on PAGE 3.

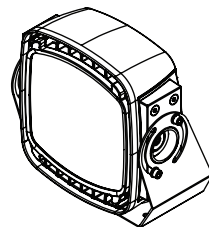
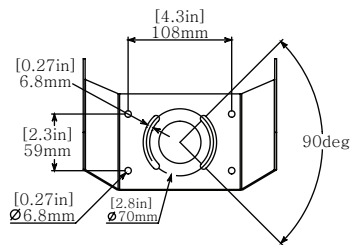
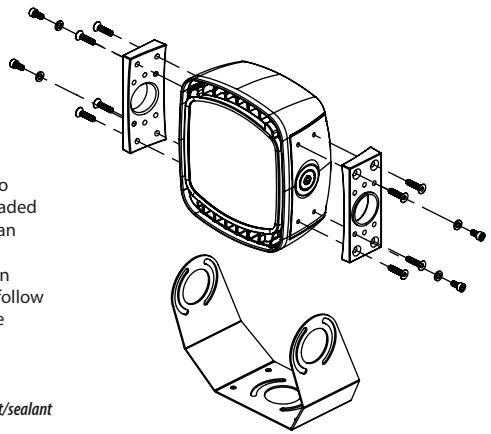

JR-YM – YOKE MOUNT INSTALLATION (Ordered Separately)

If using a different mounting accessory, refer to the corresponding page.

This JR-YM kit is intended for LC-listed JR luminaires, as marked on the luminaire nameplate.

Accessory Package Contents

JR-YM	QTY	PART NAME
	1	YOKE MOUNT A
	1	YOKE MOUNT B
	1	CHEEK PLATE
	4	1/4-20 HEX NUT
	4	1/4" FLAT WASHER
	4	1/4-20 x 0.5in CARRIAGE BOLT
	4	M6 x 25mm HEX HEAD CAP SCREW



INSTALLATION STEPS

STEP 1.

Inspect shipping package and contents to ensure no damage has occurred during shipping.

STEP 2.

Make wiring connections from branch circuit conductors to factory provided lead wires using one of the 3/4" NPT threaded entries. Follow wiring method requirements of the Canadian Electrical Code or National Electrical Code for the specific location of the installation. If installing a hazardous location model (JRXX-XXX-XXX-XX-HZ-XX) in a hazardous location, follow the hazardous location wiring method requirements of the Canadian Electrical Code or National Electrical Code.

NOTE:

To aid in assembly and provide protection against ingress, use of a petrolatum or soap thickened mineral oil based thread lubricant/sealant is necessary.

If the fixture has unused conduit openings, plug them to maintain the enclosure's integrity.

STEP 3.

Loosely assemble the yoke mount with carriage bolts on the inside washers and nuts on the outside.

NOTE:

Depending on which mounting hole is used in the curved slot, the luminaire may be configured for an upward or downward adjustable swing.

STEP 4.

Thread installed wiring through openings in the yoke mount's cheek plate and yoke mount bracket. Mount yoke assembly to luminaire using 4x M6 socket head cap screws and washers (provided). Torque fasteners to 5 Nm (45 in-lbs).

STEP 5.

Mount luminaire assembly to the desired location using 4x 1/4-20 OR M6 screws or bolts (not provided).

STEP 6.

Adjust and aim the luminaire to the desired position. Torque hardware nuts to 9 N-m (80 in-lbs).

STEP 7.

Continue installation with STEP 4 on PAGE 3.

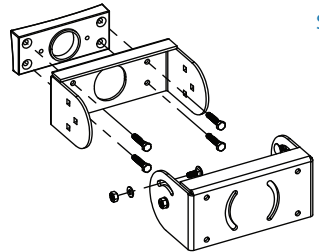

Step 3

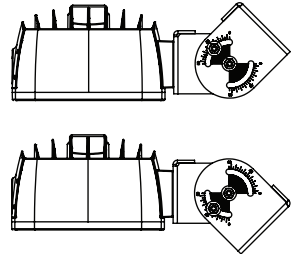

Step 5

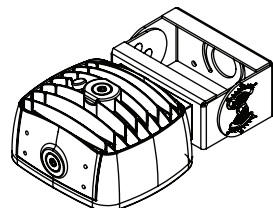
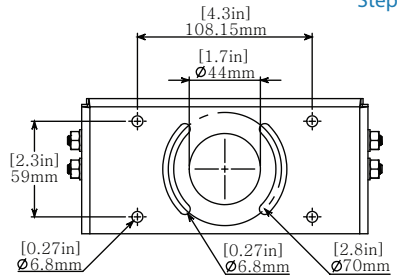

JR-HK – HOOK PENDANT INSTALLATION (Ordered Separately)

If using a different mounting accessory, refer to the corresponding page.

This JR-HK kit is intended for LC-listed JR luminaires, as marked on the luminaire nameplate.

Accessory Package Contents

JR-HK	QTY	PART NAME
	1	PENDANT HOOK ASSEMBLY
	1	ANTI-ROTATION ASSEMBLY

INSTALLATION STEPS

STEP 1.

Inspect shipping package and contents to ensure no damage has occurred during shipping.

STEP 2.

It is recommended that secondary safety cables be installed by looping appropriate steel cable or chain through the outer band of the unit and fastening a closed loop. Secondary safety hardware must be rated for a minimum of 50 lbs. Secondary safety cables made from stainless steel aircraft cable are available upon request.

STEP 3.

Slide anti-rotation lock onto suspension hook assembly and install hook assembly into 3/4" NPT threaded entry. Tighten to hand tight plus 1 to 2 turns. Slide the anti-rotation lock into place and tighten the set screw to lock the unit in place.

NOTE:

The use of a petrolatum or soap-thickened mineral oil-based thread lubricant/sealant is necessary to aid in assembly and provide protection against ingress.

If the fixture has unused conduit openings, plug them to maintain the enclosure's integrity.

STEP 4.

Latch hook onto eyebolt or other fixed mounting loop. The mounting point must be rated for a minimum of 50 lbs.

STEP 5.

Install the remaining loop of the secondary safety chain or steel cable to a suitable mounting location and fasten it securely.

STEP 6.

Continue installation with STEP 4 on PAGE 3.

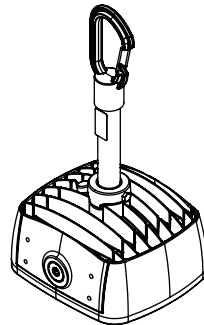
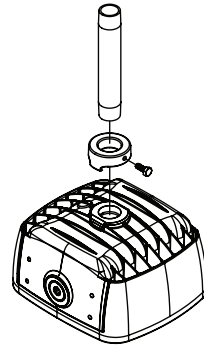

JR-CC – CONDUIT MOUNT INSTALLATION (Ordered Separately)

If using a different mounting accessory, refer to the corresponding page.

This JR-CC kit is intended for LC-listed JR luminaires, as marked on the luminaire nameplate.

Accessory Package Contents

JR-CC	QTY	PART NAME
	1	ANTI-ROTATION BRACKET ASSEMBLY

INSTALLATION STEPS

STEP 1.

Inspect shipping package and contents to ensure no damage has occurred during shipping.

STEP 2.

When using the JR-CC anti-rotation lock, slide it first onto a suitably mounted hanging conduit or luminaire hanger and loosely tightened the set screw. Fixed rigid metal conduit or luminaire hanger must be suitably mounted to prevent rotation, and the system must be rated for 50 lbs.

Install luminaire onto 3/4" NPT threaded nipple. Tighten to hand tight contact plus 1 to 2 turns. When using the JR-CC, loosen the set screw and slide JR-CC into place with flats aligned to those on the luminaire hub and tighten the set screw to lock the unit in place.

NOTE:

The use of a petrolatum or soap-thickened mineral oil-based thread lubricant/sealant is necessary to aid in assembly and provide protection against ingress.

If the fixture has unused conduit openings, plug them to maintain the enclosure's integrity.

STEP 3.

If you are utilizing a secondary safety cable, install it by looping appropriate steel cable or chain through the outer band of the unit and fastening a closed loop. Secondary safety hardware must be rated for a minimum of 50 lbs.

Install the remaining loop of the secondary safety chain or steel cable in a suitable mounting location and fasten it securely. Secondary safety hardware must be rated for 50 lbs.

STEP 4.

Continue installation with STEP 4 on PAGE 3.

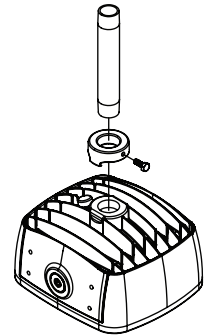

This kit contains an Anti-Rotation-Lock

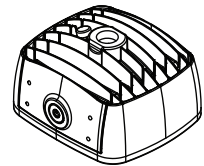

JR-SFY – SLIP FITTER YOKE MOUNT INSTALLATION (Ordered Separately)

If using a different mounting accessory, refer to the corresponding page.

This JR-SFY kit is intended for LC-listed JR luminaires, as marked on the luminaire nameplate.



WARNING/ATTENTION

Listing for Class II, Division 2, Zone 22, Class III and Nonrecessed Marine Luminaire and the IP66 or IP66/67 rating are Limited to using the mount for mechanical support only and not part of the wiring system.

Luminaires marins de classe II, division 2, zone 22, classe III, non-encastré et la classification IP66 ou IP66 / 67 sont limitées à l'utilisation du support pour un support mécanique uniquement (l'entrée de conduit 1/4" NPT couverte par le support doit être branchée à l'aide des bouchons fournis). Il n'est pas autorisé à être utilisé pour le système de câblage.



Accessory Package Contents

JR-SFY	QTY	PART NAME
	2	M6 X 16mm FLAT HEX HEAD SOCKET CAP SCREW
	1	SEALED CAP
	2	M8 X 25mm SOCKET HEAD CAP SCREWS
	6	3/8" HEX BOLTS
	4	M6 X 16mm HEX HEAD CAP SCREW
	1	SLIP FITTER YOKE MOUNT (2x PIECES)

INSTALLATION STEPS

STEP 1.

Inspect shipping package and contents to ensure no damage has occurred during shipping.

STEP 2.

Remove both M6 flat head cap screws using a 4mm hex key and remove the sealed cap. If the required angle is known, adjust the luminaire angle by loosening two M8 socket head cap screws inside the slip fitter pole mount using a 6mm hex key. After aiming torque, the M8 socket head cap screws to 17N-m (13ft-lb).

NOTE:

The aiming angle can be adjusted after Step 6.

STEP 3:

Install slip fitter pole mount onto the pole. Poles equivalent in size to 1-1/2" or 2" trade size pipe or conduit are to be used. Ensure the slip fitter pole mount is fully seated on top of the pole at the internal stops. Aim and secure the slip fitter pole mount using the six provided 3/8" hex bolts. Torque to 27N-m (20ft-lb).

NOTE:

After installation, the aim can be adjusted up to 180° in either direction by loosening the six hex bolts and tightening again to 27 N-m (20 ft-lb). DO NOT TURN BEYOND 180° as this will induce twist and strain on conductors after wiring.

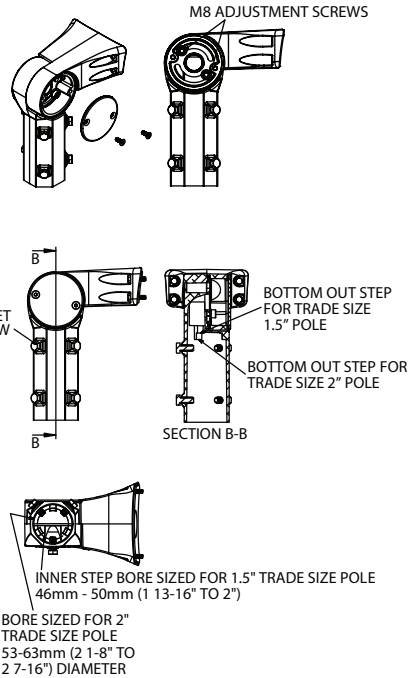

JR-SFY – SLIP FITTER YOKE MOUNT INSTALLATION CONT.

INSTALLATION STEPS CONT.

STEP 4.

Warning: The listing for Class II, Division 2, Zone 22, Class III, and Nonrecessed Marine Luminaires with the IP66 or IP66/67 rating is Limited to using the mount for mechanical support only (¾" NPT Conduit entry covered by the mount is to be plugged using provided plugs) and not part of the wiring system.

Attention: Lors de l'installation de la luminaire JR sur le support SFY, la lentille du luminaire ne doit pas être orientée vers le haut au-delà de la position verticale pour les installations en zones dangereuses de Classe II, Division 2, Zone 22 et Classe III. Reportez-vous à la figure.

Install a suitable wiring system that complies with the wiring methods permitted in the Canadian Electrical Code or the National Electrical Code for the classification of the hazardous locations area of installation.

STEP 5.

Ensure the wiring system has appropriate strain relief in the luminaire by tying a large enough knot using the supply field wiring in the wiring compartment so that it cannot be pulled through the luminaire's 3/4" nNPT entry.

STEP 6.

Secure slip fitter pole mount to luminaire with four M6 hex head cap screws provided using a 10mm socket. Torque to 7N-m (62in-lbs).

Step 7.

Close the sealed cap on the slip fitter pole mount. Torque to 7N-m (62in-lbs).

Step 8.

Continue installation with STEP 4 on PAGE 3.

