

KEY FEATURES

- Streamlined housing for quick installation and teardown
- 360° light output provides up-light and down-light
- Versatile mounting options for increased flexibility
- Field replaceable sub-assemblies and cable.

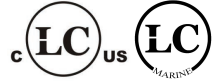

Module spacing of 8ft or less and a mounting height of 9ft or less achieves OSHA-recommended illumination levels of 5fc.



TECHNICAL SPECIFICATIONS / MAXIMUM RATINGS

HOUSING	Copper-free Cast Aluminum and Borosilicate Glass
INPUT VOLTAGE	120VAC (50/60 Hz)
RATED POWER	19.5W per module
TEMPERATURE RANGE	-50°C to +70°C (Case ~15°C above ambient)
CERTIFICATIONS	Certified to UL 844, UL 1088, CAN/ULC-S1088, UL 1598, UL 1598A; CSA 22.2 No. 137; Class I, Division 2, Groups ABCD, T5; Class II, Division 1, Groups EFG, T5; Class III; Class I, Zone 2, Groups IIC; Class I, Zone 20, Groups IIIC
INGRESS PROTECTION	IP66/67 Suitable for wet locations. Marine Outside Type (Salt water).
COLOUR TEMP RANGE	5000K Special Order: 2700-6500K
CRI VALUE (MIN)	80+
TOTAL LUMENS	1550 lumens per module
LUMEN MAINTENANCE	LM-80 > 72,000 hrs (Based on CREE long term testing)
WEIGHT	1.2 kg (2.6 lbs) per module 1.6 kg (3.5 lbs) including 10ft of cord

*The ambient temperature during lifetime, lumen and chromaticity determination is 25°C ± 1°C.

DIMENSIONS

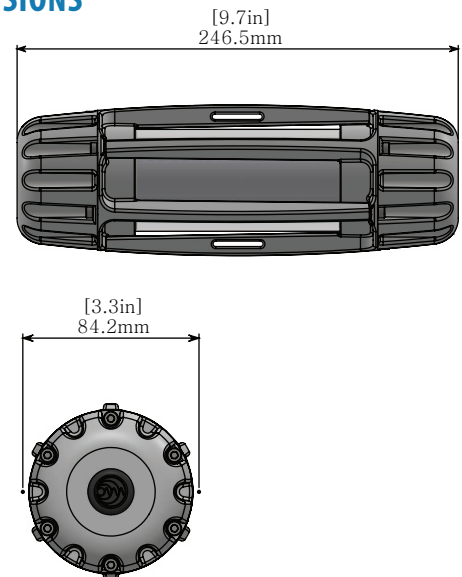

WARRANTY

Five (5) year limited warranty to the original purchaser. The warranty covers defects in materials and workmanship under normal use and service.

For additional information see:
<https://nemalux.com/legal>

MOUNTING OPTIONS

SURFACE MOUNT (LS-SM):

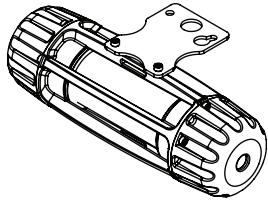

STRAP MOUNT (LS-ST):

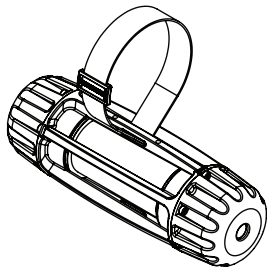

STAINLESS STEEL CLAMP MOUNT:

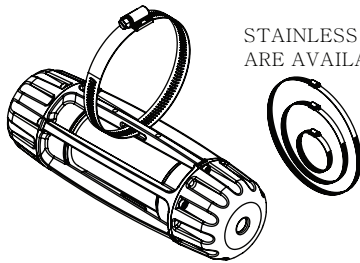

STAINLESS STEEL STRAP ACCESSORIES
ARE AVAILABLE IF REQUIRED

CONNECTOR OPTIONS

UGP51 - Killark UGP-15231QW Hazardous Location Plug:

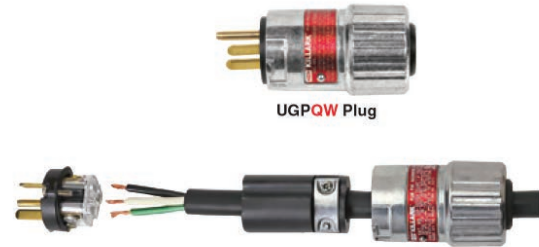

515W - Waterproof Nema 5-15 Plug (515W):



L515W - Waterproof Nema L5-15 Locking Plug:



SPACING DIAGRAM:

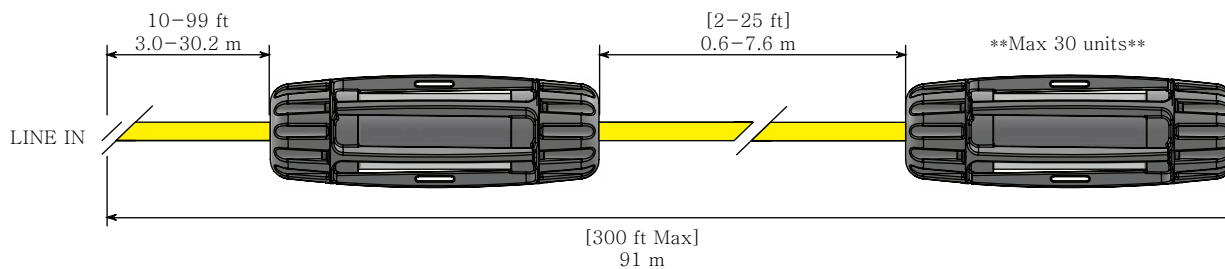

ORDERING INFORMATION

PROJECT NAME		TYPE
PROJECT LOCATION		
COMMENT		DATE
PREPARED BY		

MODEL SELECTOR

Sample Number: LS-KIT-50

MODEL	COLOUR
LS-KIT -	
	30 - 3000K 50 - 5000K
	Special Order: 2700-6500K ¹

ACCESSORIES (Order Separately)

Sample Number: LS-ST

ACCESSORY
LS-ST - 4 ft mounting strap w/ metal cam-buckle, 1" polyester or polypropylene webbing, high-visibility orange.
LS-SM - Surface Mounting Accessory
STS2 - Stainless steel mounting strap. Fits tubing 1-13/16 to 2-1/2" diameter.
STS3 - Stainless steel mounting strap. Fits tubing 2-9/16 to 3-1/4" diameter.
STS4 - Stainless steel mounting strap. Fits tubing 3-5/16 to 4-1/4" diameter.
STS5 - Stainless steel mounting strap. Fits tubing 3-5/8 to 6-1/4" diameter.
STS6 - Stainless steel mounting strap. Fits tubing 4-1/8 to 6-3/4" diameter.
STS8 - Stainless steel mounting strap. Fits tubing 5-5/8 to 8-1/4" diameter.
STS9 - Stainless steel mounting strap. Fits tubing 7-1/8 to 9-3/4" diameter.
STS12 - Stainless steel mounting strap. Fits tubing 9-3/8 to 12" diameter.

NOTES:

1. Minimum order quantities, additional costs and lead times may apply.
2. Connections using ordinary location plugs must be made outside of any hazardous classified areas.
3. Compatible with Leviton, Woodhead, Hubbell, Cooper, Ericson, and P&S waterproof receptacles.
4. Factory assembled (Just-in-time manufacturing) strings:
 - 2 to 30 units on a single string with spacing intervals of 2 ft to 25 ft
 - Standard flying lead
 - May be supplied with choice of Listed connectors suitable for classification of area of use
5. Module spacing must be 8ft or less to meet OSHA light level requirements of 5fc illuminance, for a 9ft mounting height, in an 18ft wide space, with ceiling, wall, and floor reflectance values of 70%, 50%, and 20% respectively.